



# Darshan<sup>®</sup> Lighting Luminaires

Where the light of your life begins...



## product guide

*More than thirty five + years of dedicated the customer services.*



Registration No: QAIC/IN/433-A

Effective from : Feb 2011

An ISO 9001-2008 certified company.

# ISO Certification



# Some Approvals

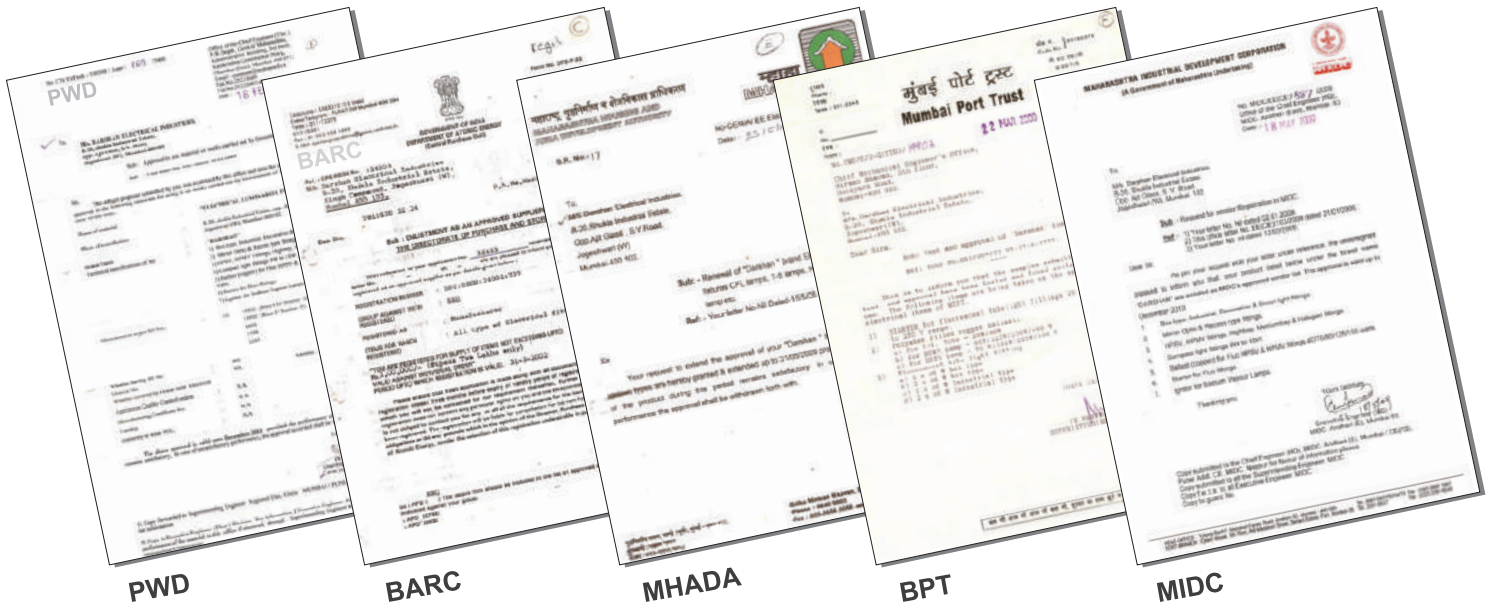

# the company



Registration No: QAIC/IN/433-A



## the company

**Darshan** luminaires takes great pleasure to introduce as a leading manufacturer of luminaires & fitting since last 35+ years. Darshan Luminaires is the market leader for a variety of domestic, commercial, Industrial, CFL, Street Light luminaires & Accessories. Darshan Luminaires has contributed significantly to the development of good lighting practices in most of the areas of application.

At the heart of the R & D Setup is the lighting laboratory for evaluation of the optical performance of the luminaire. The sophisticated laboratory, critical test equipments, electrical test facility, mechanical test facility, new products development etc. ensures the best quality product for our valued customers.

Each & Every product is tested by our technically skilled staff to meet the standard.

We design and evaluate interior & exterior installation layout in accordance with national & international standards. Our major installations cover application areas such as Indoor, Commercial, Industrial, Architectural, Residential, Street Lighting etc.

Since inception **Darshan** has kept pace with the changing demands of consumers and lifestyles by developing cutting edge technologies, innovating new concepts, improving existing products.

List of our valued clients consists of Architects, P.W.D., BMC, BARC, BPT, BEST, Industries, Corporates, Private Sectors, Leading Builders etc.

Offering the best products and establishing the good lighting practices to the satisfaction of customer is what **Darshan** has been striving for and shall continue to do so.



“When you choose **Darshan**, you are in good hands”.

## Commercial Range

8 - 10



## T5 Range

11 - 12

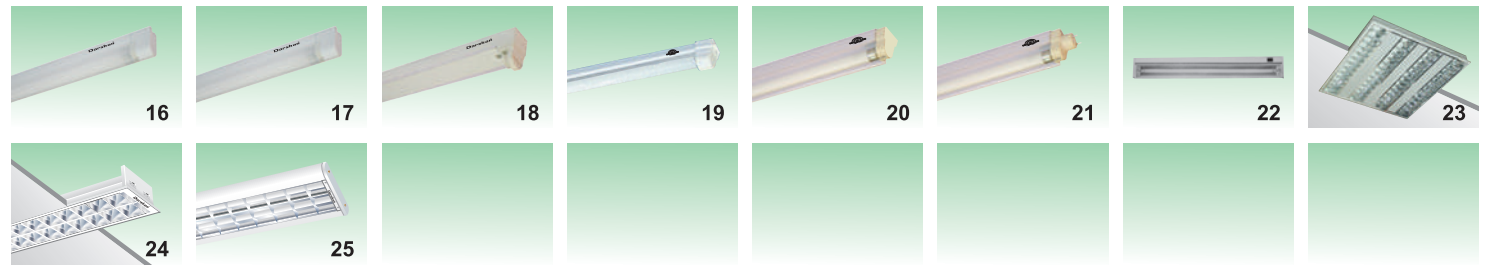

## Decorative Range

13 - 21



**Downlight Range**

**22 - 28**



**Picture Light Range**

**29**



**Metal Halide Range**

**30 - 31**



**Industrial Range**

**32 - 39**



## Industrial Range

32 - 39

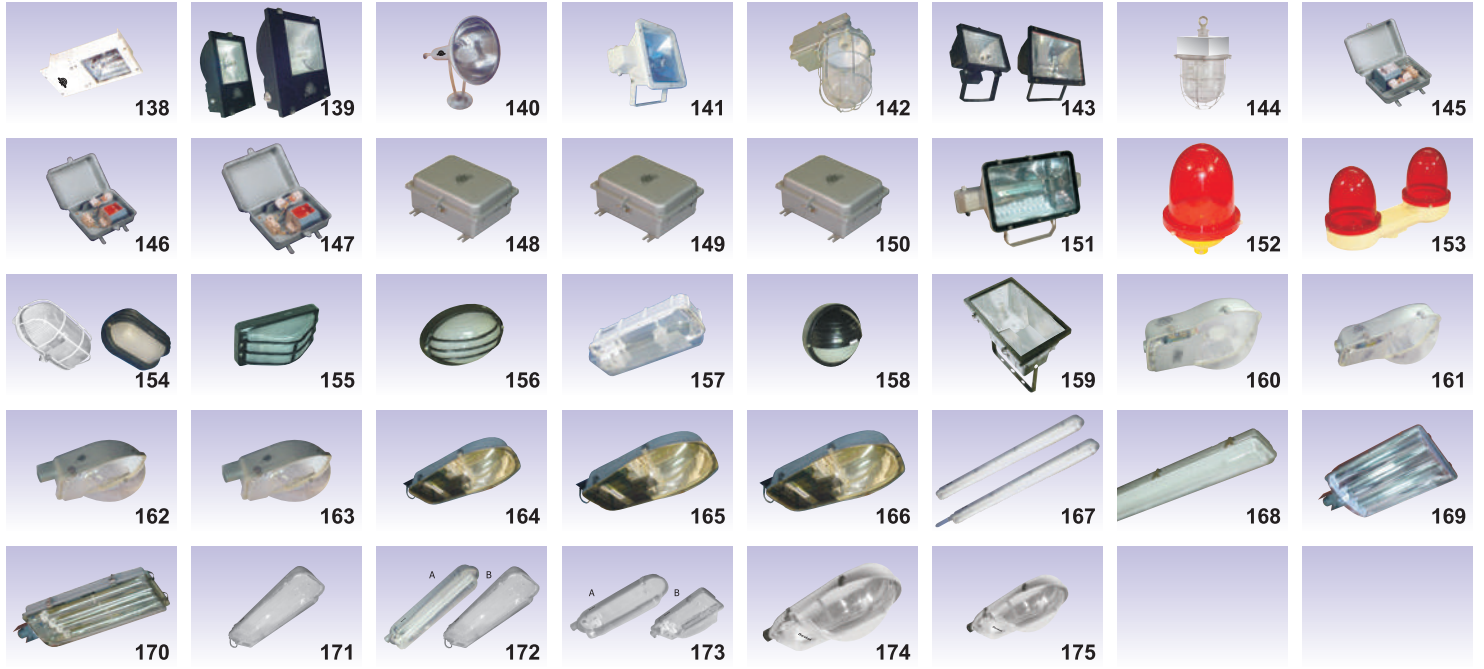

## Clean Room Range

40

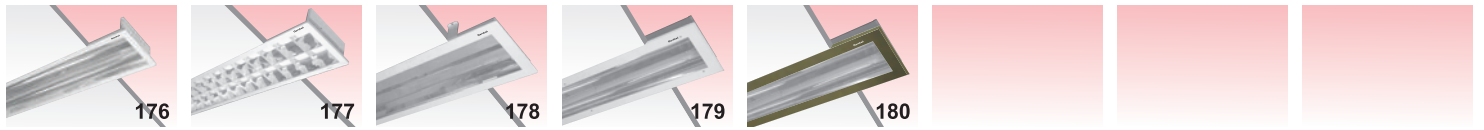

## Garden Light Range

41 - 44



## Pole Lighting

45 - 50

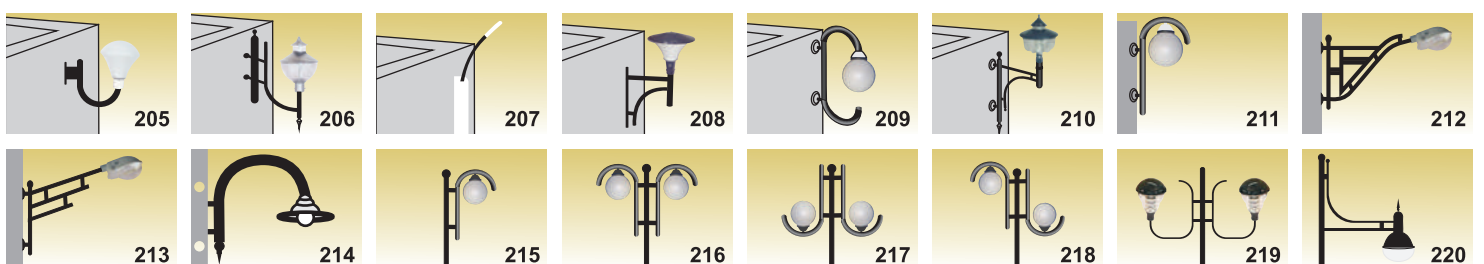

# Index



## Pole Light Range

45 - 50

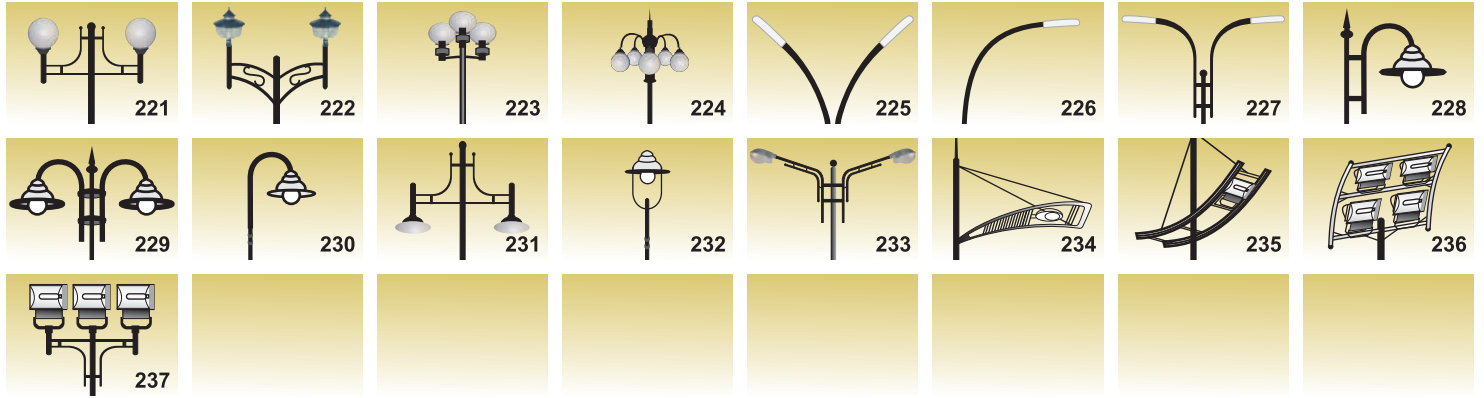

## LED Range

51 - 58







## Accessories

59 - 62

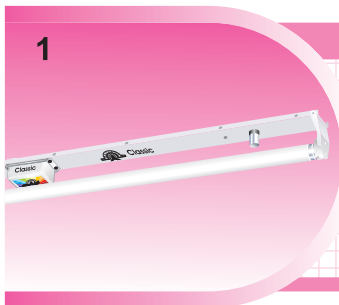
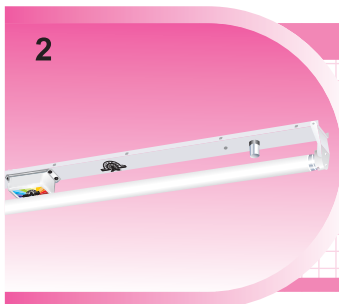

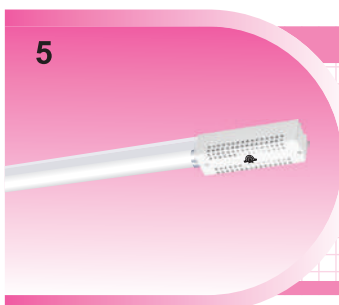
# COMMERCIAL RANGE

Product	Dimension & Description			Cat. Ref.	Pkg.	Price
	L	W	H			
	<b>Classic Patti</b>					
	2 Ft. - 610	50	110	A) DCP - 2/4 Ft.	20	
	4 Ft. - 1230	50	110			
	<b>Popular Strip (Patti)</b>					
	2 Ft. - 610	56	110	A) DPS - 2/4 Ft.	20	
	4 Ft. - 1230	50	110	B) DPS (Copper) - 2/4 Ft.	20	
	5 Ft. - 1530	58	110	C) DPS - 5 Ft.	12	
	<b>With Aluminium / Copper Ballast</b>					
	<b>With V.P.I.T. Ballast</b>					
	<b>Slim Patti</b>					
	2 Ft. - 610	38	92	A) DPS - TLD - 1x18 W	20	
	4 Ft. - 1220	40	95	B) DPS - TDL - 1x36 W	20	
	<b>With Electronic Ballast</b>					
	<b>Electronic Choke Patti</b>					
	2 Ft. - 610	38	92	A) DECP - 2 Ft.	20	
	4 Ft. - 1220	40	95	B) DECP - 4 Ft.	20	
	<b>With Aluminium Ballast</b>					
	<b>Side Choke Patti</b>					
	2 Ft. - 815	35	58	A) DSCP - 2 Ft.	20	
	4 Ft. - 1410	35	60	B) DSCP - 4 Ft.	20	
	<b>With Aluminium Ballast</b>					
	<b>Mirolta</b>					
	670	50	95	A) DM - 1x20 W	15	
	1280	50	95	B) DM - 1x40 W	12	
	670	50	95	C) DM EB - 1x20 W	15	
	1280	50	95	D) DM EB - 1x40 W	12	
				E) Extra Side Cap - 1 Pc.		
	<b>A &amp; B with Mini Copper Ballast and C &amp; D with Electronic Ballast, End cap in White colour only.</b>					



# COMMERCIAL RANGE

Product

Dimension & Description

Cat. Ref.

Pkg.

Price

L x W x H

7

## Micro Mirolta

615	30	50	A) DMM -1x18 W	15
1225	33	55	B) DMM -1x36 W	12
615	30	50	C) DMMEB-1x18 W	15
1225	33	55	D) DMMEB-1x36 W	12

A & B with V.P.I.T. Ballast and C & D with Electronic Ballast

8

## Delux Linex

308	50	70	A) DLNX -1x11 W PL	15
625	50	70	B) DLNX -1x20 W	15
1240	50	70	C) DLNX -1x40 W	12

With V.P.I.T. Ballast

9

## P. L. Mirolta

A

B

315	50	95	A) DPL-M -1x11 W	15
570	50	95	B) DPL-M -2x11 W	10
315	50	95	C) DPL-M EB -1x11 W	15
570	50	95	D) DPL-M EB -2x11 W	10

A & B with P. L. Copper Ballast and C & D with Electronic Ballast, Clear / Lining / Crystal acy. Diffuser, End cap in White colour only.

10

## Slim Mirolta

640	33	75	A) DSM TLD -1x18 W	15
1270	33	75	B) DSM TLD -1x36 W	12
			C) Extra side cap - 1Pc.	

With V.P.I.T. Ballast, End cap in White colour only.

11

## Commercial Box Fitting

630	65	100	A) DCB -1x20 W	12
1240	65	100	B) DCB -1x40 W	12
630	65	100	C) DCB EB -1x20 W	12
1240	65	100	D) DCB EB -1x40 W	12

A & B with Aluminium Ballast and C & D with Electronic Ballast.

12

## Commercial Box Fitting

630	65	100	A) DCB -2x20 W	10
1240	65	100	B) DCB -2x40 W	10
630	65	100	C) DCB EB -2x20 W	10
1240	65	100	D) DCB EB -2x40 W	10

With Aluminium Ballast

Product	Dimension & Description			Cat. Ref.	Pkg.	Price
	L	x	W x H			

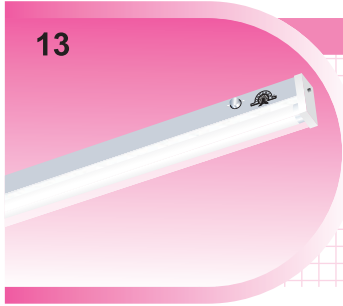

**Janta Decorative**

630	62	100	A) DJA - 1x20 W	10
1240	62	100	B) DJA - 1x40 W	10
630	104	100	C) DJA - 2x20 W	10
1240	104	100	D) DJA - 2x40 W	10
630	62	100	E) DJA EB - 1x20 W	10
1240	62	100	F) DJA EB - 1x40 W	10
630	104	100	G) DJA EB - 2x20 W	10
1240	104	100	H) DJA EB - 2x40 W	10

A to D with Aluminium Ballast and E to H with Electronic Ballast. Acrylic Diffuser are Milky / Clear



**P. L. Janta**

260	50	78	A) DPL - J -1x9/11 W PL	25
-----	----	----	-------------------------	----

With Mini Copper Ballast & Clear / Diamond Diffuser



**P. L. Side Choke Janta**







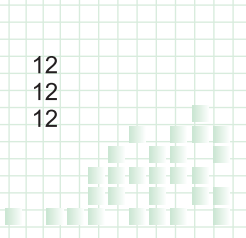

380	42	36	A) DPL - SCJ -1x11 W PL	20
-----	----	----	-------------------------	----

With V.P.I.T. Ballast

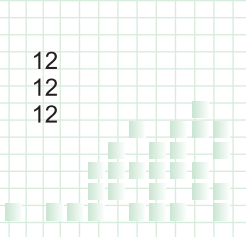

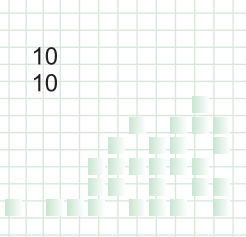

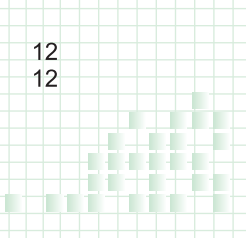

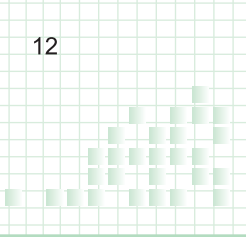
# T-5 RANGE

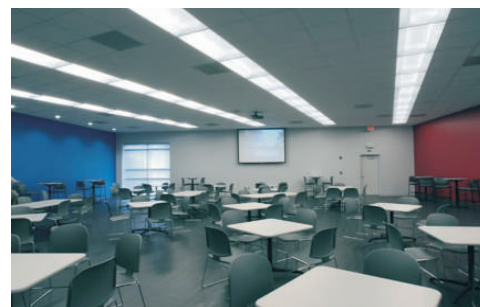
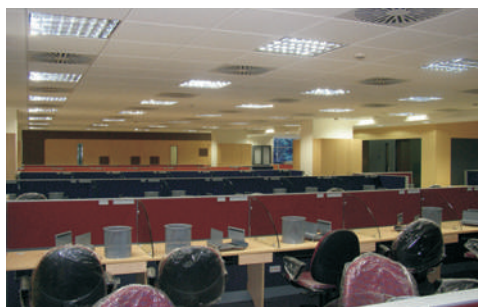

Product	Dimension & Description			Cat. Ref.	Pkg.	Price
	L	x W	x H			
<b>16</b> 	<b>T-5 Mirolta with Cover (Linkable)</b>			A) D T-5 ML -1x8 W	12	
				B) D T-5 ML -1x13 W	12	
			C) D T-5 ML -1x28 W	12		
<b>With Electronic Ballast &amp; Tube</b>						
<b>17</b> 	<b>T-5 Mirolta with Cover (Non-Linkable)</b>			A) D T-5 MNL -1x8 W	12	
				B) D T-5 MNL -1x13 W	12	
			C) D T-5 MNL -1x28 W	12		
<b>With Electronic Ballast &amp; Tube</b>						
<b>18</b> 	<b>T-5 Slim Box Fitting</b>			A) D T-5 -1x28 W	10	
	1180	45	70	B) D T-5 -2x28 W	10	
1180	45	70				
<b>With Electronic Ballast</b>						
<b>19</b> 	<b>T-5 Slim Mirolta</b>			A) DSM T-5 -14 W	12	
	180	30	545	B) DSM T-5 -28 W	12	
590	30	545				
<b>With Electronic Ballast</b>						
<b>20</b> 	<b>T-5 Oval Mirolta</b>			A) D T-5 OM -28 W	12	
<b>With Electronic Ballast &amp; Tube</b>						

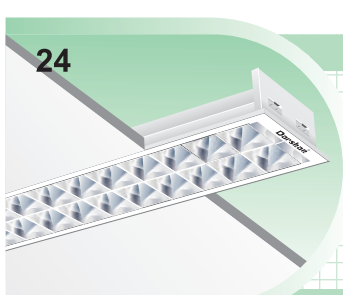

Product	Dimension & Description			Cat. Ref.	Pkg.	Price
	L	W	H			
<b>21</b> 	<b>T-5 Retrofit Fitting</b>			A) D T-5 RF -1x28 W	20	
	<b>With Electronic Ballast &amp; Tube</b>					
<b>22</b> 	<b>T-5 Swivel Wall Lamp</b>			A) D T-5 SWL - 8 W	10	
	575	90	30	B) D T-5 SWL -13 W	10	
	575	90	30			
<b>With Electronic Ballast &amp; Tube</b>						
<b>23</b> 	<b>T5 Extrone</b>			A) D T-5 EX -4x14 W	3	
	580	580	60	B) D T-5 EX -4x24 W	3	
	580	580	60			
<b>With Electronic Ballast</b>						
<b>24</b> 	<b>T-5 Mirror Optic Recessed</b>			A) D T-5 MOR -1x28 W	3	
	1225	165	100	B) D T-5 MOR -2x28 W	3	
	1235	230	100			
<b>With Electronic Ballast</b>						
<b>25</b> 	<b>T-5 Mirror Optic Surface</b>			A) D T-5 MOS -1x28 W	4	
	1245	230	71	B) D T-5 MOS -2x28 W	4	
	1240	320	70			
<b>With Electronic Ballast</b>						

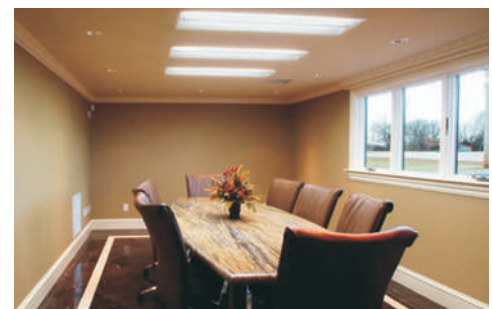
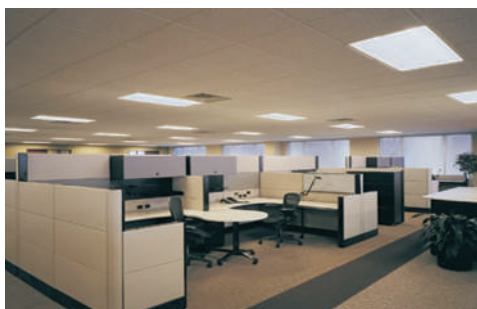

# DECORATIVE RANGE



Product	Dimension & Description			Cat. Ref.	Pkg.	Price
	L	x W	x H			
	<b>Wall Line Corner</b>					
	640	170	125	A) DWLC -120 W	6	
	1245	170	125	B) DWLC -140 W	6	
	640	170	125	C) DWLC -220 W	6	
	1245	170	125	D) DWLC -240 W	6	
	640	170	125	E) DWLC EB -120 W	6	
	1245	170	125	F) DWLC EB -140 W	6	
	640	170	125	G) DWLC EB -220 W	6	
	1245	170	125	H) DWLC EB -240 W	6	

Acrylic Diffuser are Milky / Clear A, B, C & D Aluminium Ballast and E, F, G & H Electronic Ballast

	<b>Simi Light Corner</b>					
	390	97	75	A) D - SLC -1x11 W PL	12	
	625	95	68	B) D - SLC -2x11 W PL OPP	9	
	625	95	68	C) D - SLC -1x36 W PLL	9	

With Mini Copper Ballast

	<b>Simi Light Corner S. S.</b>					
	380	95	70	A) D-SLC-SS -1x11 W PL	12	
	650	95	70	B) D-SLC-SS -2x11 W PL OPP	9	
	650	95	70	C) D-SLC-SS -1x36 W PLL	9	

With V.P.I.T. Ballast

	<b>Simi Light</b>					
	345	95	45	A) D-Simi -1x11 W PL	12	
	630	95	45	B) D-Simi -2x11 W PL OPP	12	
	630	95	45	C) D-Simi -1x36 W PLL	12	
	860	95	45	D) D-Simi -1x18 W TLD	9	
	1475	95	45	E) D-Simi -1x36 W TLD	9	
	860	95	45	F) D-Simi -2x18 W TLD	9	
1475	95	45	G) D-Simi -2x36 W TLD	9		

With Mini Copper Ballast

	<b>Simi Light S. S.</b>					
	322	95	48	A) D-Simi-SS -1x11 W PL	12	
	655	95	45	B) D-Simi-SS -2x11 W PL OPP	12	
	655	95	45	C) D-Simi-SS -1x36 W PLL	12	
	915	95	45	D) D-Simi-SS -1x18 W TLD	9	
	1505	95	45	E) D-Simi-SS -1x36 W TLD	9	
	915	95	45	F) D-Simi-SS -2x18 W TLD	9	
1505	95	45	G) D-Simi-SS -2x36 W TLD	9		

With V.P.I.T. Ballast

# DECORATIVE RANGE

Product	Dimension & Description			Cat. Ref.	Pkg.	Price
	L	W	H			
 <b>31</b>	<b>Crommy with AP Louver</b>					
	360	105	30	A) D-Crmy-AP-1x11 W PL	12	
	490	105	30	B) D-Crmy-AP-1x36 W PLL	10	
	1320	110	25	C) D-Crmy-AP-1x36 W TLD	5	
	360	105	30	D) D-Crmy EB-1x11 W PL	12	
	490	105	30	E) D-Crmy EB-1x36 W PLL	10	
	1320	110	25	F) D-Crmy EB-1x36 W TLD	5	

**A, B & C V.P.I.T. Ballast and D, E & F Electronic Ballast**

 <b>32</b>	<b>Crommy-SS with AP Louver</b>					
	360	105	30	A) D-Crmy-AP SS -1x11 W PL	12	
	490	105	30	B) D-Crmy-AP SS -1x36 W PLL	10	
	1320	110	25	C) D-Crmy-AP SS -1x36 W TLD	5	
	360	105	30	D) D-Crmy EB-AP SS-1x11 W PL	12	
	490	105	30	E) D-Crmy EB-AP SS-1x36 W PLL	10	
	1320	110	25	F) D-Crmy EB-AP SS-1x36 W TLD	5	

**A, B & C V.P.I.T. Ballast and D, E & F Electronic Ballast**

 <b>33</b>	<b>Crommy with Acrylic</b>					
	360	105	30	A) D-Crmy-ACY -1x11 W PL	12	
	490	105	30	B) D-Crmy-ACY -1x36 W PLL	10	
	1320	110	25	C) D-Crmy-ACY -1x36 W TLD	5	
	360	105	30	D) D-Crmy EB-ACY-1x11 W PL	12	
	490	105	30	E) D-Crmy EB-ACY-1x36 W PLL	10	
	1320	110	25	F) D-Crmy EB-ACY-1x36 W TLD	5	

**A, B & C V.P.I.T. Ballast and D, E & F Electronic Ballast**

 <b>34</b>	<b>Crommy-SS with Acrylic</b>					
	360	105	30	A) D-Crmy-ACY SS -1x11 W PL	12	
	490	105	30	B) D-Crmy-ACY SS -1x36 W PLL	10	
	1320	110	25	C) D-Crmy-ACY SS -1x36 W TLD	5	
	360	105	30	D) D-Crmy EB-ACY SS-1x11 W PL	12	
	490	105	30	E) D-Crmy EB-ACY SS-1x36 W PLL	10	
	1320	110	25	F) D-Crmy EB-ACY SS-1x36 W TLD	5	

**A, B & C V.P.I.T. Ballast and D, E & F Electronic Ballast**

 <b>35</b>	<b>Salute Light SS</b>					
	305	105	100	A) D-Salute-SS -1x11 W PL	12	
	500	95	95	B) D-Salute-SS -1x36 W PLL	12	

**With V.P.I.T. Ballast**

# DECORATIVE RANGE



Product

Dimension & Description  
L x W x H

Cat. Ref.

Pkg.

Price

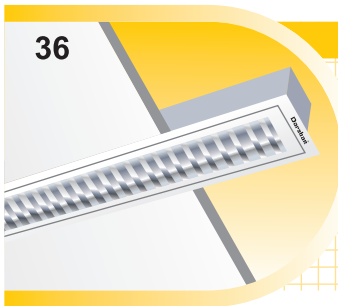

### Dark Liner

620	95	105	A) DDL	-1 x 20W	6
1225	95	105	B) DDL	-1 x 40W	6
625	230	120	C) DDL	-2 x 20W	3
1230	235	110	D) DDL	-2 x 40W	3
620	95	105	E) DDL EB	-1 x 20W	6
1225	95	105	F) DDL EB	-1 x 40W	6
625	230	120	G) DDL EB	-2 x 20W	3
1230	235	110	H) DDL EB	-2 x 40W	3

A, B, C & D Aluminium Ballast and E, F, G & H Electronic Ballast



### Dark Liner Sq. Louver.

620	95	105	A) DDL SQ	-1 x 20W	6
1225	95	105	B) DDL SQ	-1 x 40W	6
625	230	120	C) DDL SQ	-2 x 20W	3
1230	235	110	D) DDL SQ	-2 x 40W	3
620	95	105	E) DDL EB SQ	-1 x 20W	6
1225	95	105	F) DDL EB SQ	-1 x 40W	6
625	230	120	G) DDL EB SQ	-2 x 20W	3
1230	235	110	H) DDL EB SQ	-2 x 40W	3

ABS Chromium Plated Louvers. A, B, C & D Aluminium Ballast and E, F, G & H Electronic Ballast



### Recess Fitting

640	240	85	A) DRF	-2x20 W	3
1235	240	105	B) DRF	-2x40 W	3
640	240	85	C) DRF EB	-2x20 W	3
1235	240	105	D) DRF EB	-2x40 W	3

Acrylic diffusers are Milky or Clear. A & B Aluminium Ballast and C & D Electronic Ballast



### Unicess Mirror Optic

620	200	80	A) DUMO	-2x20 W	3
1230	200	80	B) DUMO	-2x40 W	3
620	200	80	C) DUMO EB	-2x20 W	3
1230	200	80	D) DUMO EB	-2x40 W	3

A & B Mini Copper Ballast and C & D Electronic Ballast

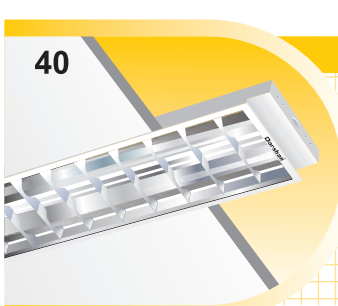

### M.O. Arm Strong Fitting

570	570	100	A) DASF	-4x18W	3
570	570	100	B) DASF EB	-4x18W	3

A Mini Copper Ballast and B Electronic Ballast

Product	Dimension & Description			Cat. Ref.	Pkg.	Price
	L	x	W x H			



### Mirror Optic Recessed

620	165	100	A) DMO-R	-1x20 W	3
1225	168	100	B) DMO-R	-1x40 W	3
630	230	100	C) DMO-R	-2x20 W	3
1235	230	100	D) DMO-R	-2x40 W	3
620	165	100	E) DMO-R EB	-1x20 W	3
1225	168	100	F) DMO-R EB	-1x40 W	3
630	230	100	G) DMO-R EB	-2x20 W	3
1235	230	100	H) DMO-R EB	-2x40 W	3

A, B, C & D Mini Copper Ballast and E, F, G & H Electronic Ballast

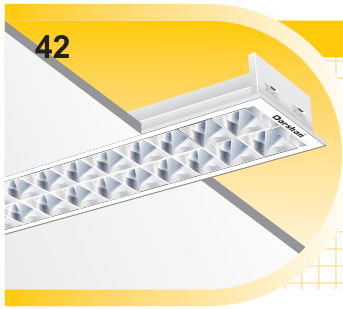

### M. O. Double Parabolic

1225	165	100	A) DMO-DP	-1x36 W	3
630	230	100	B) DMO-DP	-2x18 W	3
1235	230	100	C) DMO-DP	-2x36 W	3
570	570	100	D) DMO-DP	-4x18 W	3
1225	165	100	E) DMO EB-DP	-1x36 W	3
630	230	100	F) DMO EB-DP	-2x18 W	3
1235	230	100	G) DMO EB-DP	-2x36 W	3
570	570	100	H) DMO EB-DP	-4x18 W	3

A, B, C & D Mini Copper Ballast and E, F, G & H Electronic Ballast



### Mirror Optic Surface

1245	230	71	A) DMO-S	-1x40 W	4
635	320	70	B) DMO-S	-2x20 W	4
1240	320	70	C) DMO-S	-2x40 W	4
1245	230	71	D) DMO-EB-S	-1x40 W	4
635	320	70	E) DMO-EB-S	-2x20 W	4
1240	320	70	F) DMO-EB-S	-2x40 W	4

Wall Mounting. A, B & C Mini Copper Ballast and D, E & F Electronic Ballast

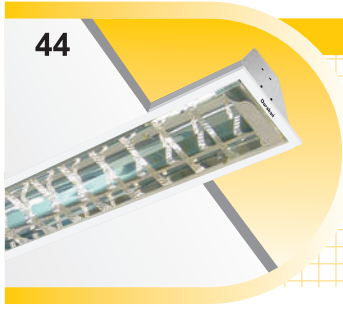

### VX Fitting

615	135	100	A) D-VX	-1x18 W	3
1230	135	100	B) D-VX	-1x36 W	3
615	165	100	C) D-VX	-2x18 W	3
1230	165	100	D) D-VX	-2x36 W	3
455	135	100	E) D-VX	-1x36 W PLL	6
455	165	100	F) D-VX	-2x36 W PLL	6

Full Refelctor with V.P.I.T. Ballast

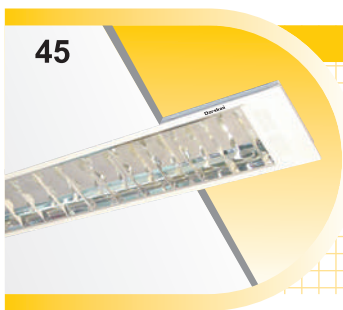

### DP-LX Fitting

715	115	45	A) D-DPLX	-1x18 W TLD	5
1325	120	50	B) D-DPLX	-1x36 W TLD	5
705	156	45	C) D-DPLX	-2x18 W TLD	5
1320	170	45	D) D-DPLX	-2x36 W TLD	5
580	120	45	E) D-DPLX	-1x36 W PLL	8
550	156	45	F) D-DPLX	-2x36 W PLL	8

With Mini Copper Ballast



# DECORATIVE RANGE



Product

Dimension & Description  
L x W x H

Cat. Ref.

Pkg.

Price

46

### SQ-LX With Glass

280	280	50	A) D-LXG	-2x18 W PLL	6
463	463	50	B) D-LXG	-3x36 W PLL	3
280	180	50	C) D-LXG EB	-2x18 W PLL	6
463	463	50	D) D-LXG EB	-3x36 W PLL	3

A & B with Mini Copper Ballast and C & D with Electronic Ballast

47

### SQ-LX SS Frame with Glass

280	280	50	A) D-LXG-SS	-2x18 W PLL	6
463	463	50	B) D-LXG-SS	-3x36 W PLL	3
280	280	50	C) D-LXG EB-SS	-2x18 W PLL	6
463	463	50	D) D-LXG EB-SS	-3x36 W PLL	3

A & B with Mini Copper Ballast and C & D with Electronic Ballast

48

### Perforated Recess

285	285	75	A) D-PR	-2x18 W PLL	6
495	280	80	B) D-PR	-2x36 W PLL	4
580	580	65	C) D-PR	-3x36 W PLL	3
285	285	75	D) D-PR EB	-2x18 W PLL	6
495	280	80	E) D-PR EB	-2x36 W PLL	4
580	580	65	F) D-PR EB	-3x36 W PLL	3

A, B & C with Mini Copper Ballast and D, E & F with Electronic Ballast

49

### Pera Soft Light

570	580	75	A) DPSL	-2x36 W PLL	2
570	580	75	B) DPSL EB	-2x36 W PLL	2

A with Mini Copper Ballast and B with Electronic Ballast

50

### Soft Light Prolux

570	580	75	A) DSLP	-2x18 W PLL	6
570	580	75	B) DSLP	-2x36 W PLL	2
			C) DSLP EB	-2x18 W PLL	6
			D) DSLP EB	-2x36 W PLL	2

A & B with Mini Copper Ballast and C & D with Electronic Ballast

# DECORATIVE RANGE

Product	Dimension & Description			Cat. Ref.	Pkg.	Price
	L	W	H			

51

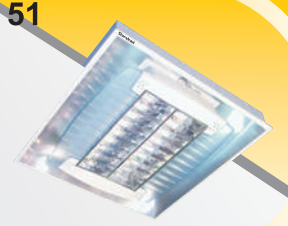

**Soft Light Wings**

580	580	75	A) DSLW -2x36 W PLL	3
580	580	75	B) DSLW EB -2x36 W PLL	3

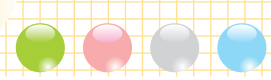

**Colour of side wings Clear/ Blue    A with Mini Copper Ballast and B with Electronic Ballast**

52



**Wall Washer**

450	285	115	A) DWW-R -1x36 W PLL	3
1225	280	100	B) DWW-R -1x40 W	3
450	285	115	C) DWW-R EB -1x36 W PLL	3
1225	280	100	D) DWW-R EB -1x40 W	3

**A, & B with Mini Copper Ballast and C & D with Electronic Ballast**

53



**Perforated Surface with ABS Louvers**

255	255	50	A) DPS -2x18 W PLL	6
560	560	63	B) DPS -3x36 W PLL	3
255	255	50	C) DPS EB -2x18 W PLL	6
560	560	63	D) DPS EB -3x36 W PLL	3

**A & B with Mini Copper Ballast and C & D with Electronic Ballast**

54



**Pyramid Surface SS with Glass**

260	140	45	A) DPSSG -1x18 W PL	10
260	260	45	B) DPSSG -2x18 W PL	10
500	190	45	C) DPSSG -1x36 W PLL	6
505	260	45	D) DPSSG -2x36 W PLL	6
505	505	45	E) DPSSG -3x36 W PLL	3

**With Mini Copper Ballast**

55

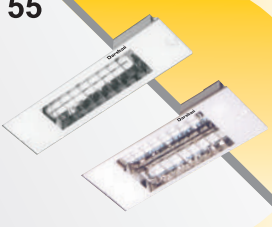

**PL-LX Range**

330	90	40	A) DLX -1x11 W PL	10
340	165	40	B) DLX -2x11 W PL	10
275	100	45	C) DLX -1x18 W PL	10
280	165	40	D) DLX -2x18 W PL	10
625	95	40	E) DLX O -2x11 W PL	10
565	130	45	F) DPL-LX -1x36 W PLL	10
620	175	45	G) DPL-LX -2x36 W PLL	8

**With Mini Copper Ballast**

# DECORATIVE RANGE



Product

Dimension & Description  
L x W x H

Cat. Ref.

Pkg.

Price

56



**PL - LX Surface**

305	255	70	A) DLS	-2x11 W PL	10
280	165	40	B) DLS	-2x18 W PL	10
305	255	70	C) DLS EB	-2x11 W PL	10
280	165	40	D) DLS EB	-2x18 W PL	10

**A & B with Mini Copper Ballast and C & D with Electronic Ballast**

57

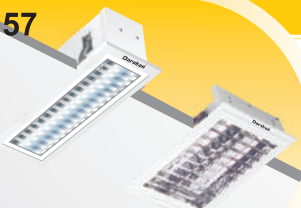

**PL Dark Liner / SQ Louver**

275	90	90	A) DDL	-1x9/11 W PL	10
280	240	95	B) DDL	-2x9/11 W PL	6
280	240	95	C) DDL-SQ	-2x9/11 W PL	6
275	90	90	D) DDL EB	-1x9/11 W PL	10
280	240	95	E) DDL EB	-2x9/11 W PL	6
280	240	95	F) DDL EB-SQ	-2x9/11 W PL	6

**A, B & C with Mini Copper Ballast and D, E & F with Electronic Ballast**

58



**PL - LX SS Range**

330	90	40	A) DLX-SS	-1x11 W PL	10
340	165	40	B) DLX-SS	-2x11 W PL	10
565	130	45	C) DPL LX-SS	-1x36 W PLL	10
620	175	45	D) DPL LX-SS	-2x36 W PLL	8
330	90	40	E) DLX EB-SS	-1x11 W PL	10
340	165	40	F) DLX EB-SS	-2x11 W PL	10
565	130	45	G) DPL LX EB-SS	-1x36 W PLL	10
620	175	45	H) DPL LX EB-SS	-2x36 W PLL	8

**A, B, C & D with Mini Copper Ballast and E, F, G & H with Electronic Ballast**

59



**PL - LX With Glass**

315	95	40	A) DLX-G	-1x11 W PL	10
315	155	40	B) DLX-G	-2x11 W PL	10
500	140	50	C) DPL LX-G	-1x36 W PLL	10
500	210	50	D) DPL LX-G	-2x36 W PLL	8
315	95	40	E) DLX EB-G	-1x11 W PL	10
315	155	40	F) DLX EB-G	-2x11 W PL	10
500	140	50	G) DPL LX EB-G	-1x36 W PLL	10
500	210	50	H) DPL LX EB-G	-2x36 W PLL	8

**A, B, C & D with Mini Copper Ballast and E, F, G & H with Electronic Ballast**

60



**PL - LX SS with Glass**

315	95	40	A) DLX-G SS	-1x11 W PL	10
315	155	40	B) DLX-G SS	-2x11 W PL	10
500	140	50	C) DPL LX-G SS	-1x36 W PLL	10
500	210	50	D) DPL LX-G SS	-2x36 W PLL	8
315	95	40	E) DLX EB-G SS	-1x11 W PL	10
315	155	40	F) DLX EB-G SS	-2x11 W PL	10
500	140	50	G) DPL LX EB-G SS	-1x36 W PLL	10
500	210	50	H) DPL LX EB-G SS	-2x36 W PLL	8

**A, B, C & D with Mini Copper Ballast and E, F, G & H with Electronic Ballast**

# DECORATIVE RANGE

Product	Dimension & Description				Cat. Ref.	Pkg.	Price
	L	x	W	x			

61

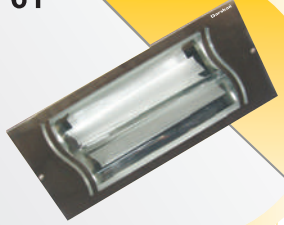

**LX-SS-S-Cut**

500	140	50	A) DLX-GSS-SC	-1x36 W PLL	10
500	210	50	B) DLX-GSS-SC	-2x36 W PLL	8
500	140	50	C) DLX EB-GSS-SC	-1x36 W PLL	10
500	210	50	D) DLX EB-GSS-SC	-2x36 W PLL	8

A & B with Mini Copper Ballast and C & D with Electronic Ballast

62



**Tubiller**

460	165	40	A) DT -1x36 W PLL	10
460	230	40	B) DT -2x36 W PLL	10
570	570	50	C) DT -3x36 W PLL	3

With Mini Copper Ballast

63

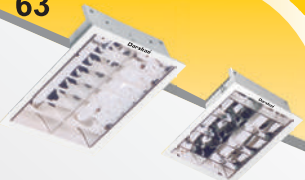

**P.L. Mirror Optic Recess/Double Parabolic**

275	230	90	A) DMO	-2x11 W PL	6
275	230	90	B) DDP	-2x11 W PL	6
275	230	90	C) DMO EB	-2x11 W PL	6
275	230	90	D) DDP EB	-2x11 W PL	6

A & B with Mini Copper Ballast and C & D with Electronic Ballast

64

A



B



**Ceiling Light Round**

200	200	65	A) DCR	-1x10/13 W PL	8
280	280	70	B) DCR	-2x10/13 W PL	8

With Mini Copper Ballast

65



**Ceiling Light Round**

340	340	100	A) DCR	-1x9/13/18 W PL	6
340	340	100	B) DCR	-2x9/13/18 W PL	6

With Mini Copper Ballast

66



**Ceiling Light Round SS**

200	200	65	A) DCLR SS	-1x10 W PL	3
280	280	70	B) DCLR SS	-2x10/13 W PL	3

With Mini Copper Ballast

# DECORATIVE RANGE

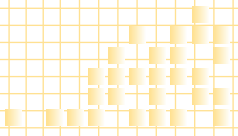

Product	Dimension & Description			Cat. Ref.	Pkg.	Price
	L	W	H			

	<b>Foot Light</b>			A) DPLG -10 W	15	
	210	90	65			
<b>Without Ballast</b>						

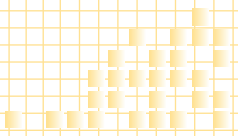

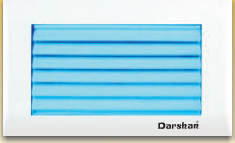
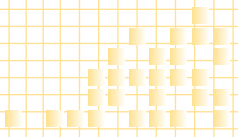

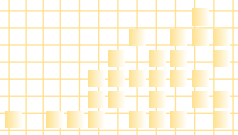

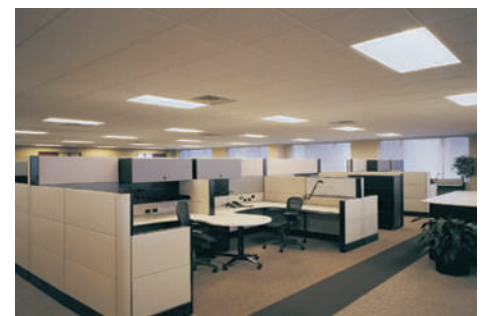
	<b>Foot Light SS Frame</b>			A) DFLSS -1x18 W PL	8	
	200	200	70			
<b>With V.P.I.T. Ballast</b>						

	<b>Foot Light With LED</b>			A) D-LED-Foot Light	15	
	105	55	20			
<b>With LED Driver</b>						

	<b>Foot Light SS with LED</b>			A) D-LED-Foot Light SS	15	
	105	55	20			
<b>With LED Driver</b>						









# DOWN LIGHT RANGE







Product	Dimension & Description		Cat. Ref.	Pkg.	Price
	D	x H			
	<b>PL Down Light Bowl</b>				
	155	100	A) DDLB -1x9 W PL	9	
	155	100	B) DDLB -2x9 W PL	9	
	155	100	C) DDLB -1x13/18 W PL	9	
	155	100	D) DDLB -2x13/18 W PL	9	
	188	100	E) DDLB -2x26 W PL	9	
<b>B with Single Ballast Only; A,C, &amp; D with PL Copper Ballst &amp; E with V.P.I.T. Copper Ballast.</b>					
	<b>Down Light Bowl With PC Curve Refelctor</b>				
	165	110	A) DDLBPCCR -2x13 W PL	9	
	165	110	B) DDLBPCCR -2x18 W PL	9	
<b>With PL Copper Ballast</b>					
	<b>Deep Down Bowl With PC Refelctor</b>				
	180	155	A) D-DDBPCR -2x13 W PL	9	
	180	155	B) D-DDBPCR -2x18 W PL	9	
<b>With PL Copper Ballast</b>					
	<b>Down Light Bowl With Sand Reflector</b>				
	165	125	A) DDLBSBR -1x18 W PL	9	
	165	125	B) DDLBSBR -2x18 W PL	9	
<b>With PL Copper Ballast</b>					
	<b>PL Turbo</b>				
	160	115	A) D-Turbo -2x18 W PL	9	
<b>With PL Copper Ballast</b>					
	<b>Bowl With Glass</b>				
	160	100	A) DBG -1x13/18 W PL	9	635.00
	160	100	B) DBG -2x13/18 W PL	9	950.00
<b>With PL Copper Ballast</b>					

# DOWN LIGHT RANGE



Product	Dimension & Description		Cat. Ref.	Pkg.	Price
	D	x H			
<b>77</b> 	<b>PL Diffuser</b>				
	160	95	A) DDF -1x13/18 W PL	9	
	160	95	B) DDF -2x13/18 W PL	9	
<b>With PL Copper Ballast</b>					
<b>78</b> 	<b>SS Bowl Movement Fitting</b>				
	160	105	A) DBMSS -1x13/18 W PL	9	
	160	105	B) DBMSS -2x13/18 W PL	9	
<b>With PL Copper Ballast</b>					
<b>79</b> 	<b>Bowl Movement Fitting-White</b>				
	160	105	A) D-BM -1x13/18 W PL	9	
	160	105	B) D-BM -2x13/18 W PL	9	
<b>With PL Copper Ballast</b>					
<b>80</b> 	<b>New Bowl Movement SS</b>				
	160	110	A) DNBMS -1x13/18 W PL	9	
	160	110	B) DNBMS -2x13/18 W PL	9	
	190	85	C) DNBMS -1x26 W PL	9	
	190	85	D) DNBMS -2x26 W PL	9	
<b>A &amp; B With PL Copper Ballast and C &amp; D With V.P.I.T. Copper Ballast.</b>					
<b>81</b> 	<b>New Bowl Movement</b>				
	160	110	A) DNBM -1x13/18 W PL	9	
	160	110	B) DNBM -2x13/18 W PL	9	
	109	105	C) DNBM -1x26 W PL	9	
	109	105	D) DNBM -2x26 W PL	9	
<b>A &amp; B With PL Copper Ballast and C &amp; D With V.P.I.T. Copper Ballast.</b>					
<b>82</b> 	<b>Bowl Movement With PC Reflector</b>				
	160	80	A) D-BMPCR -2x13/18 W PL	9	
	190	90	B) D-BMPCR -2x26 W PL	9	
<b>A With PL Copper Ballast and B With V.P.I.T. Copper Ballast.</b>					

# DOWN LIGHT RANGE

Product	Dimension & Description			Cat. Ref.	Pkg.	Price
	D	x	H			
<b>83</b> 	<b>Bowl Movement With PC sand Refelctor</b>					
	170		85	A) D-BMPCSBR -2x13 W PL	9	
	170		85	B) D-BMPCSBR -2x18 W PL	9	
	<b>With PL Copper Ballast</b>					
<b>84</b> 	<b>SS. Bowl With Glass</b>					
	190		90	A) D-BGSS -2x26 W PL	9	
	<b>With V.P.I.T. Copper Ballast</b>					
<b>85</b> 	<b>Small SS. Bowl Movement</b>					
	120		60	A) D-SSSBM -1x13 W PL	9	
	120		60	B) D-SSSBM -2x18 W PL	9	
	<b>With PL Copper Ballast</b>					
<b>86</b> 	<b>PL Cone Movement Fitting -SS</b>					
	90		130	A) D-CMSS -1x10 W PL	12	
	90		145	B) D-CMSS -1x13 W PL	12	
	100		155	C) D-CMSS -1x18 W PL	12	
	<b>With PL Copper Ballast</b>					
<b>87</b> 	<b>PL Cone Movement Fitting</b>					
	90		130	A) D-CM -1x10 W PL	12	
	90		145	B) D-CM -1x13 W PL	12	
	100		155	C) D-CM -1x18 W PL	12	
	<b>With PL Copper Ballast</b>					
<b>88</b> 	<b>SQ SS Bowl With Full Glass</b>					
	145	145	70	A) DBFGSS -1x13/18 W PL	9	
	145	145	70	B) DBFGSS -2x13/18 W PL	9	
	145	145	70	C) DBFGSS -2x26 W PL	9	
	<b>With PL Copper Ballast</b>					

L x W x H







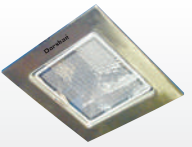
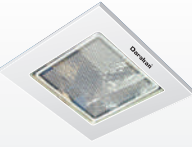
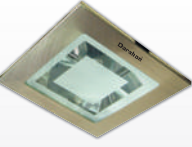
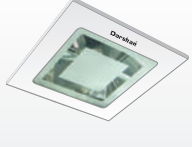
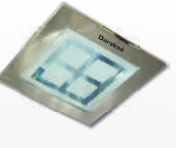
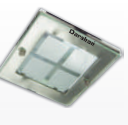

# DOWN LIGHT RANGE







Product	Dimension & Description			Cat. Ref.	Pkg.	Price
	L	W	H			
	<b>Sq. SS Bowl</b>					
	145	145	70	A) DB-SS -1x13/18 W PL	9	
	145	145	70	B) DB-SS -2x13/18 W PL	9	
	<b>With PL Copper Ballast</b>					
	<b>Sq. White Bowl</b>					
	145	145	70	A) D-SQ WB -1x13/18 W PL	9	
	145	145	70	B) D-SQ WB -2x13/18 W PL	9	
	<b>With PL Copper Ballast</b>					
	<b>Sq. SS Bowl With Inner Glass</b>					
	140	140	70	A) D-SQ SSBIG -1x13/18 W PL	9	
	140	140	70	B) D-SQ SSBIG -2x13/18 W PL	9	
	<b>With PL Copper Ballast</b>					
	<b>SQ. White Bowl With Inner Glass</b>					
	140	140	70	A) D-SQ WBIG -1x13/18 W PL	9	
	140	140	70	B) D-SQ WBIG -2x13/18 W PL	9	
	<b>With PL Copper Ballast</b>					
	<b>Small Sq. SS Bowl With Inner Glass</b>					
	120	120	60	A) D-SQ SSSBIG -2x13 W PL	9	
	<b>With PL Copper Ballast</b>					
	<b>Small Sq. SS Bowl With Full Glass</b>					
	90	90	70	A) D-SQ SSSBFG -2x10 W PL	9	
	<b>With PL Copper Ballast</b>					

# DOWN LIGHT RANGE



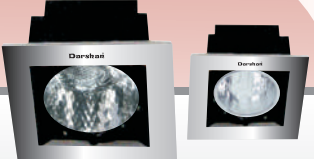
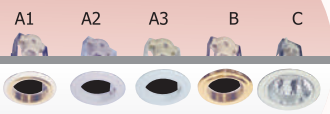

Product	Dimension & Description			Cat. Ref.	Pkg.	Price
	L	W	H			
<b>95</b> 	<b>PL. SQ. SS Cone Movement</b>					
	90	90	140	A) D- SQ SSSCM -1x10 W PL	12	
	<b>With PL Copper Ballast</b>					
	<b>D</b>	<b>x</b>	<b>H</b>			
<b>96</b> 	<b>Bowl Surface</b>					
	215		110	A) DBS -1x13 W PL B) DBS -1x18 W PL C) DBS -2x13 W PL D) DBS -2x18 W PL	8 8 8 8	
	<b>With PL Copper Ballast</b>					
<b>97</b> 	<b>PL Cone Sq. SS</b>					
	75 75 100		105 105 155	A) DC-SS -1x10 W PL B) DC-SS -1x13 W PL C) DC-SS -1x18 W PL	12 12 12	
	<b>With PL Copper Ballast</b>					
<b>98</b> 	<b>PL Highbay Bowl</b>					
	315		350	A) DHB-Acrylic-2 x 13/18 WPL	2	
	<b>With VPIT Ballast</b>					
<b>99</b> 	<b>PL Surface Down Light</b>					
	270		70	A) DSDL -2x26 W PL	8	
	<b>With VPIT Ballast</b>					
<b>100</b> 	<b>Cylinder Cone</b>					
	A & B		C & D	A) DSC -1x13 W CONE B) DSC -1x18 W CONE C) DSD -2x13 W PL D) DSD -2x18 W PL	8	
	<b>With Open Copper Ballast</b>					

# DOWN LIGHT RANGE

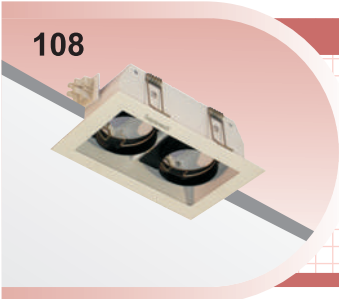
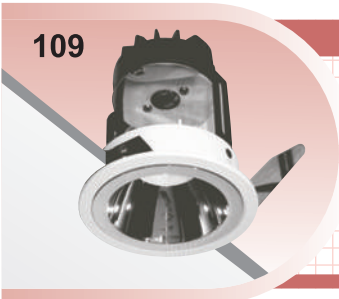

Product	Dimension & Description		Cat. Ref.	Pkg.	Price
	D	x H			
<b>101</b>  DSD-SS    DSC-SS	<b>Square S.S. Cone w/o glass (adjustable)</b>				
			A) DSC-SS -1x13 W PL B) DSC-SS -1x18 W PL C) DSD-SS -2x13 W PL D) DSD-SS -2x18 W PL	15 15 10 10	
	<b>With Open Copper Choke</b>				
<b>102</b> 	<b>Spot Light G.L.S. Lamp</b>				
			A) DSGL -I-V-Gold/IV/White B) DSGL -Brass Gold C) DSGL -AL-Cone No.1	12 12 12	
	75	120			
	75	120			
	95	195			
<b>103</b> 	<b>PL Cone Fitting</b>				
			A) DCF -1x10 W PL CONE NO. 0 B) DCF -1x13 W PL CONE NO. 1 C) DCF -1x 9 W PL CONE NO. 2 D) DCF -1x18 W PL CONE NO. 2	12 12 12 12	
	90	120			
	95	145			
	120	185			
	120	185			
	<b>With PL Copper Ballast</b>				
<b>104</b> 	<b>Spot Light 12 V / 50 W Halogen Fitting</b>				
			A) DS-HF -12V / 50W(WH) B) DSC-HF -12V / 50W(WH) C) DSO-SS-HF -12V / 50W D) DSF-SS-HF -12V / 50W	15 15 15 15	
	75	40			
	<b>With choke &amp; Lamp Holder</b>				
	<b>1. Regular</b>		<b>3. Oval Type</b>		
	<b>2. Casting Body</b>		<b>4. Flower Type</b>		
<b>105</b> 	<b>Deluxe Sq. 12/50 Spot Light</b>				
			A) DDSQ-HF -12 V / 50 W B) DD -HF -12 V / 50 W	15 15	
	65	20			
	70	25			
	<b>With choke &amp; Lamp Holder</b>				
	<b>1. Brush Nickel SQ-Two Ton</b>		<b>3. Brush Nickel Two Ton</b>		
	<b>2. Brush Gold SQ-Two Ton</b>		<b>4. Brush Gold Two Ton</b>		
<b>106</b> 	<b>Zoom 12/50 Spot Light</b>				
			A) DZ-SS-HF -12 V / 50 W B) DZ-HF -12 V / 50 W	15 15	
	90	85			
	90	85			
	<b>With choke &amp; Lamp Holder</b>				
	<b>1. Zoom SS</b>				
	<b>2. Zoom Regular White</b>				

# DOWN LIGHT RANGE

Product	Dimension & Description		Cat. Ref.	Pkg.	Price
	D	x H			
	<b>Sq. Deep Glass</b>				
	150	75	A) DSDG-SS -1x10/13/18W	15	
	150	75	B) DSDG-SS -2x10/13/18W	10	
	150	75	C) DSDG -1x10/13/18W	15	
	150	75	D) DSDG -2x10/13/18W	10	
	<b>With PL Copper Ballast</b>				
	<b>Sq. Spot Light 12 / 50 W</b>				
			A) DSQ-HF -1x12/50 W	15	
			B) DSQ-HF -2x12/50 W	15	
			C) DSQ-HF -3x12/50 W	15	
			D) DSQ-HF -4x12/50 W	15	
	<b>With Electronics Ballast &amp; Lamp Holder</b>				
	<b>12 x 50 Fixed Spot Light</b>				
	90	130	A) DFSL -12V / 50W	15	
	<b>With Electronic Ballast &amp; Reflector</b>				
	<b>12 x 50 Rotable Spot Light</b>				
	90	100	A) DRSL -12V / 50W	15	
	<b>With Electronic Ballast &amp; Reflector</b>				
	<b>12 x 50 Fixed Spot Light with Glass</b>				
	90	40	A) DFSLG -12V / 50W	15	
	<b>With Electronic Ballast &amp; Reflector</b>				
	<b>Track Light</b>				
			A) D - Track	10	
			B) D - Track Fitting	10	
			C) D - Accessories - I,L	10	
			D) D - Accessories - -L,+	10	
	<b>With Electronic Ballast</b>				





# PICTURE LIGHT RANGE

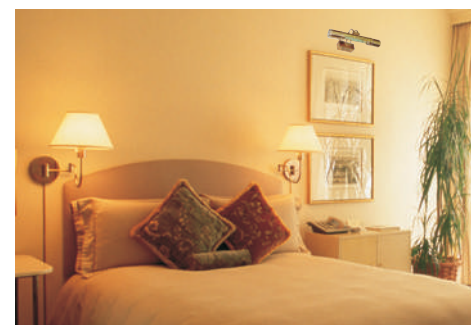

Product	Dimension & Description					Cat. Ref.	Pkg.	Price
	L	x	W	x	H			
<b>113</b> 	<b>Single Candle</b>					A) DSC -E-14	15	
	Brush Steel Brush Gold	Antic Copper Antic Gold						
<b>114</b> 	<b>Double Candle</b>					A) DDC -E-14	15	
	Brush Steel Brush Gold	Antic Copper Antic Gold						
<b>115</b> 	<b>Pen mirchi</b>					A) DPM -12/20 W (mirchi)	15	
	Brush Steel Brush Gold	Antic Copper Antic Gold				With Electronic Ballast Without Driver		
<b>116</b> 	<b>Pictura</b>					A) DP -11 W PL	15	
	Brush Steel Brush Gold	Antic Copper Antic Gold				With V.P.I.T. Ballast		
<b>117</b> 	<b>Wall Bracket Light</b>					A) DWBL -2 X 11 W PL	15	
		264	155	115		L 264/155/115 mm	With Electronic Ballast & Lamp	





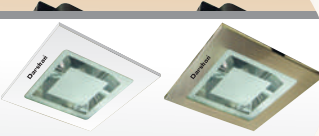
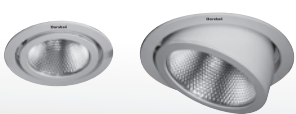



# METAL HALLIDE RANGE

Product	Dimension & Description		Cat. Ref.	Pkg.	Price
	D	x H			
<b>118</b> 	<b>Deluxe Indoor M.H.D.</b>				
	160	110	A) D-DIMHD - 70 WDE	8	
	160	110	B) D-DIMHD -150 WDE	8	
	<b>Without Choke (IBU)</b>				
<b>119</b> 	<b>Metal Hallide Fitting Indoor</b>				
	170	80	A) D-MHF - 70 WDE	8	
	170	80	B) D-MHF -150 WDE	8	
	<b>Without Choke (IBU)</b>				
<b>120</b> 	<b>MHD Bowl Movement</b>				
	155	75	A) D-MHDBM - 70 WDE	8	
	155	75	B) D-MHDBM -150 WDE	8	
	<b>Without Ballast</b>				
<b>121</b> 	<b>MHD SS Bowl Movement</b>				
	155	75	A) D-MHD BM-SS - 70 WDE	8	
	155	75	B) D-MHD BM-SS -150 WDE	8	
	<b>Without Ballast</b>				
<b>122</b>  <b>A &amp; B</b> <b>C &amp; D</b>	<b>MHD SQ. BOWL</b>				
	140	70	A) D-MHD SQ B- 70 W DE	8	
	140	70	B) D-MHD SQ B- 150 W DE	8	
	140	70	C) D-MHD SQ SSB- 70 W DE	8	
	140	70	D) D-MHD SQ SSB- 150 W DE	8	
	<b>A &amp; B Powder Coated and C&amp;D SS</b>				
	<b>Without Ballast</b>				
<b>123</b> 	<b>CDMT Movable</b>				
	147	150	A) D-MHD SQ SSB-	8	
	185	190	B) D-MHD SQ SSB-	8	
	<b>Without Ballast</b>				

# METAL HALLIDE RANGE



Product	Dimension & Description		Cat. Ref.	Pkg.	Price
	D	x H			
<b>124</b> 	<b>CDMT Zoom Fitting</b>				
	120	150	A) D-CDMTF - 35 W	8	
	120	150	B) D-CDMTF - 70 W	8	
	120	150	C) D-CDMTF -150 W	8	
	<b>Without Ballast</b>				
<b>125</b> 	<b>CDMT SQ. Zoom Fitting</b>				
	120	100	A) D-CDMT SQ ZF - 35 W	8	
	120	100	B) D-CDMT SQ ZF - 70 W	8	
	120	100	C) D-CDMT SQ ZF-150 W	8	
	<b>Without Ballast</b>				
<b>L x W x H</b>					
<b>126</b> 	<b>MHD SQ. SS Zoom Indoor Fitting</b>				
	225	130 120	A) D-MHF - 150 W	8	
	<b>Without Choke (IBU)</b>				
<b>D x H</b>					
<b>127</b> 	<b>MHD Outdoor Fitting</b>				
	220	115	A) D-MHF - 70 W	8	
	220	115	B) D-MHF -150 W	8	
	<b>Without Choke (IBU)</b>				
<b>128</b> 	<b>Sq. CDMT Adjustable Fitting</b>				
	155	135	A) D-SQA-CDMT - 35 W	6	
	155	135	B) D-SQA-CDMT - 70 W	6	
	155	135	C) D-SQA-CDMT -150 W	6	
	<b>Without Ballast</b>				
<b>129</b> 	<b>CDMT Adjustable Fitting</b>				
	155	135	A) D-RA-CDMT - 35 W	6	
	155	135	B) D-RA-CDMT - 70 W	6	
	155	135	C) D-RA-CDMT -150 W	6	
	<b>Without Ballast</b>				

# INDUSTRIAL INDOOR OUTDOOR RANGE

Product	Dimension & Description			Cat. Ref.	Pkg.	Price
	L	W	H			
	<b>Chalk Board</b>					
	1240	155	115	A) DCB - 1 x 40 W	10	
	1240	155	115	B) DCB - 2 x 40 W	10	
	1240	155	115	C) DCBEB - 1 x 40 W	10	
	1240	155	115	D) DCBEB - 2 x 40 W	10	

**A & B with H.D. Ballast and C & D with Electronic Ballast - Application on School Black Board**

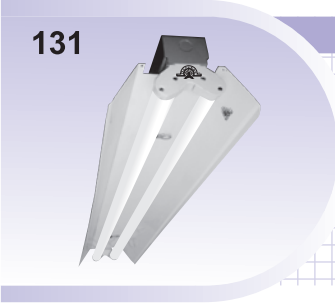
	<b>Industrial Fitting</b>					
	635	230	125	A) DIF - 1 x 20 W	10	
	1240	200	115	B) DIF - 1 x 40 W	10	
	635	230	125	C) DIF - 2 x 20 W	10	
	1240	200	115	D) DIF - 2 x 40 W	10	
	635	230	125	E) DIFEB - 1 x 20 W	10	
	1240	200	115	F) DIFEB - 1 x 40 W	10	
	635	230	125	G) DIFEB - 2 x 20 W	10	
	1240	200	115	H) DIFEB - 2 x 40 W	10	

**A, B, C & D with H.D. Ballast and E, F, G, & H with Electronic Ballast.**

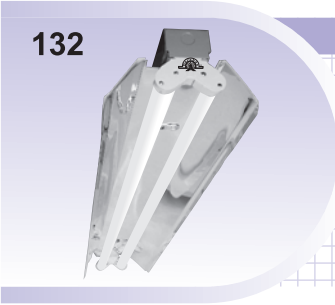
	<b>Industrial Fitting with Imported Reflector</b>					
	1240	200	115	A) DIF-WIMPR - 1 x 40 W	10	
	1240	230	115	B) DIF-WIMPR - 2 x 40 W	10	
	1240	200	115	C) DIFEB-WIMPR - 1 x 40 W	10	
	1240	230	115	D) DIFEB-WIMPR - 2 x 40 W	10	

**A, B with H.D. Ballast and C, D with Electronic Ballast, with Imported Aluminium Reflector**

Product	D x H		Cat. Ref.	Pkg.	Price
	D	H			
	<b>High Bay Integral M.V. / S.V. Fitting</b>				
	610	515	A) DHB-MV - 250 W	2	
	610	515	B) DHB-MV - 400 W	2	
	660	515	C) DHB-SV - 150 W	2	
	660	515	D) DHB-SV - 250 W	2	
	660	515	E) DHB-SV - 400 W	2	

**High Bay capsule IP-55  
Lamp compartment IP-20**

	<b>High Bay Integral MHL Fitting</b>				
	610	515	A) DHB-MHL - 250 W	2	
	610	515	B) DHB-MHL - 400 W	2	

**High Bay capsule IP-55  
Lamp compartment IP-20**



# INDUSTRIAL INDOOR OUTDOOR RANGE









Product	Dimension & Description			Cat. Ref.	Pkg.	Price
	D	x	H			
	High Bay Integral M.V./S.V. With T Glass					
	515		610	A) DHB-MV-TG - 250 W	2	
	515		610	B) DHB-MV-TG - 400 W	2	
	515		660	C) DHB-SV-TG - 150 W	2	
	515		660	D) DHB-SV-TG - 250 W	2	
	515		660	E) DHB-SV-TG - 400 W	2	
<b>With Toughened Glass</b>						
	High Bay Integral Fitting - Hook Reflector					
	515		410	A) DHB-HR - 85 W CFL	4	
	515		410	B) DHB-HR-TG - 65 W CFL	4	
<b>A) Hook Bowl Reflector Highbay fitting</b> <b>B) Hook Bowl Reflector Highbay fitting with Toughened Glass</b>						
	L x W x H					
	Lowbay Integral Fitting					
	395	65	230	A) DLBF-SV - 70 W ( Without Ignitor )	3	
	395	65	230	B) DLBF-MV - 80 W	3	
	395	65	230	C) DLBF-MV - 125 W	3	
<b>With In-built Ballast</b>						
	Silk Lowbay M.H.D. Fitting					
	420	240	115	A) D-SLB MHDF - 70 W	8	
				B) D-SLB MHDF -150 W	8	
<b>With In Built Ballast</b>						
	Tempo Flood Light					
	360	250	125	A) D-TFL - 70 W MHD-DE	2	
	360	250	125	B) D-TFL -150 W MHD-DE	2	
	450	400	165	C) D-TFL -250 W MHD-TU	2	
	450	400	165	D) D-TFL -400 W MHD-TU	2	
<b>With In Built Ballast &amp; Toughened, IP-65</b>						
	General Purpose Flood Light					
	370	235	450	A) 9" ( D-GLS-100 W / 200 W )	2	
	440	315	455	B) 12" ( D-GLS-300 W )	2	
	565	445	630	C) 18" ( D-GLS-500 W, 1000 W )	2	
150, 250, 400 W SV 250, 400 W MV						
<b>Without Control Gear Box, With Toughened Glass, IP-65</b>						

# INDUSTRIAL INDOOR OUTDOOR RANGE





Product	Dimension & Description			Cat. Ref.	Pkg.	Price
	L	W	H			
<b>141</b> 	<b>Sq. Flood Light</b>					
	210	160	135	A) DSQ-MHD-FD - 70 W	2	
	310	250	170	B) DSQ-MHD-FD - 150 W	2	
	485	365	200	C) DSQ-MHD-FD - 250 W	2	
	485	365	200	D) DSQ-MHD-FD - 400 W	2	
	485	365	200	E) DSQ-SV-FD - 250 W TU	2	
	485	365	200	F) DSQ-SV-FD - 400 W TU	2	
<b>Without CGB With Tuffend Glass, IP-65</b>						
<b>142</b> 	<b>Well Glass Fitting</b>					
	185	185	275	A) DWGF-200 W GLS/160 MLL	4	
	285	185	325	B) DWGF-SV-70 W ( Without Ignitor )	4	
	285	185	325	C) DWGF-MV-80 /125 W	4	
<b>With Tuffend Glass</b>						
<b>143</b> 	<b>Helogen Fitting</b>					
	210	160	135	A) DHF - 500 W	10	
	310	250	170	B) DHF - 1000 W	6	
<b>Casting Body - With Tuffend Glass</b>						
<b>144</b> 	<b>Integral Hooktype Wellglass Fitting</b>					
	185	185	325	A) DWGHF-SV-70 W ( Without Ignitor )	4	
	185	185	325	B) DWGHF-MV-80 /125 W	4	
<b>With Inbuild Ballast</b>						
<b>145</b> 	<b>Control Gear Box for HPMV Lamp</b>					
	285	210	135	A) DCGB-MV - 80 W	3	
	285	210	135	B) DCGB-MV - 125 W	3	
	285	210	135	C) DCGB-MV - 250 W	3	
	285	210	135	D) DCGB-MV - 400 W	3	
<b>Waterproof Control Gear Box - IP65</b>						
<b>146</b> 	<b>Control Gear Box for HPSV Lamp</b>					
	285	210	135	A) DCGB-SV - 70 W (Without Ignitor)	3	
	285	210	135	B) DCGB-SV - 150 W	3	
	285	210	135	C) DCGB-SV - 250 W	3	
	285	210	135	D) DCGB-SV - 400 W	3	
<b>Waterproof Control Gear Box - IP65</b>						

# INDUSTRIAL INDOOR OUTDOOR RANGE



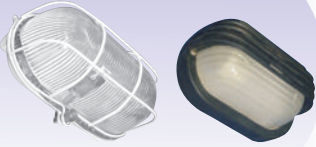





Product	Dimension & Description			Cat. Ref.	Pkg.	Price
	L	x	W x H			
<b>147</b> 	<b>Control Gear Box for MHD Lamp</b>					
	285		210 x 135	A) DCGB-MHD - 70 W	3	
	285		210 x 135	B) DCGB-MHD - 150 W	3	
	285		210 x 135	C) DCGB-MHD - 250 W	3	
	285		210 x 135	D) DCGB-MHD - 400 W	3	
<b>Waterproof Control Gear Box - IP65</b>						
<b>148</b> 	<b>Casting Control Gear Box for HPMV Lamp</b>					
	290		235 x 135	A) DCCGB-MV - 80 W	3	
				B) DCCGB-MV - 125 W	3	
				C) DCCGB-MV - 250 W	3	
				D) DCCGB-MV - 400 W	3	
<b>Waterproof Control Gear Box - IP65</b>						
<b>149</b> 	<b>Casting Control Gear Box for HPSV Lamp</b>					
	290		235 x 135	A) DCCGB-SV- 70 W (Without Ignitor)	3	
				B) DCCGB-SV- 150 W	3	
				C) DCCGB-SV- 250 W	3	
				D) DCCGB-SV- 400 W	3	
<b>Waterproof Control Gear Box - IP65</b>						
<b>150</b> 	<b>Casting Control Gear Box for MHD Lamp</b>					
	290		235 x 135	A) DCCGB-MHD - 70 W	3	
				B) DCCGB-MHD - 150 W	3	
				C) DCCGB-MHD - 250 W	3	
				D) DCCGB-MHD - 400 W	3	
<b>Waterproof Control Gear Box - IP65</b>						
<b>151</b> 	<b>Sq. Flood Light</b>					
	760		350 x 180	A) DHM-MHD - 2 x 250 W	2	
				B) DHM-MHD - 2 x 400 W	2	
<b>Casting body and T Glass without Control Gear Box</b>						
<b>152</b> 	<b>Aviation Light</b>					
				A) DAL Single	8	
				B) DAL Double	8	
Internal Thread Diameter (A) 3/4 inch (B) 1 inch						
<b>Waterproof Aviation Light Luminaire</b>						

# INDUSTRIAL INDOOR OUTDOOR RANGE



Product	Dimension & Description			Cat. Ref.	Pkg.	Price
	L	W	H			
<b>153</b> 	<b>Aviation Light with LED</b>			A) DALLED - Single	8	
				B) DALLED - Double	8	
Internal Thread Diameter (A) 3/4 inch (B) 1 inch						
<b>Waterproof Aviation Light Luminaire - LED</b>						
<b>154</b> 	<b>Bulk Head Fitting</b>			A) DBH-60/100 W GLS	15	
	200	130	110	B) DBH-Capsul-60/100 W GLS	15	
				A) Casting Body & Lock Type		
				B) Plastic Body		
<b>155</b> 	<b>SQ. Bulk Head Fitting</b>			A) DBH-E - 14 W SQ	10	
	265	145	115	B) DBH-CFL - 5 W SQ	10	
				C) DBH-CFL - 8 W SQ	10	
				D) DBH-CFL - 11 W SQ	10	
				E) DBH-CFL - 13 W SQ	10	
				F) DBH-CFL - 18 W SQ	10	
<b>Waterproof Bulkhead Fitting - IP65</b>						
<b>156</b> 	<b>Eye Bulk Head Fitting</b>			A) DEBH- - 5 W CFL	10	
	215	145	115	B) DEBH- - 11 W CFL SPIRAL	10	
<b>Waterproof Bulkhead Fitting - IP65</b>						
<b>157</b> 	<b>PL Bulk Head</b>			A) DBH - 1 x 9 W PL	15	
	210	80	80			
<b>Waterproof Bulkhead Fitting - IP65 With V.P.I.T. Ballast.</b>						
<b>158</b> 	<b>Moon Bulk Head</b>			A) DMBH- - 5 W CFL	10	
	215	145	115	B) DMBH- - 11 W CFL SPIRAL	10	
<b>Waterproof Bulkhead Fitting - IP65</b>						

# INDUSTRIAL INDOOR OUTDOOR RANGE





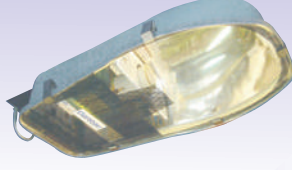

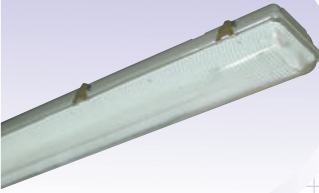
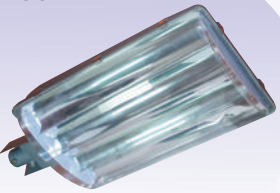
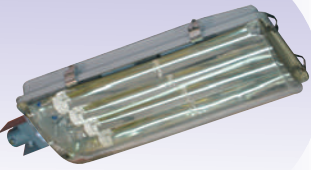
Product	Dimension & Description			Cat. Ref.	Pkg.	Price
	L	x W	x H			
	<b>UP Light</b>			A) DUL - 70 W	3	
				B) DUL - 150 W	3	
<b>With In Built Ballast, IP-65</b>						
	<b>M.V. Street Light Sheet Metal 1 PC Body</b>			A) DSLSM-MV - 80 W	2	
				B) DSLSM-MV - 125 W	2	
			C) DSLSM-MV - 250 W	2		
			D) DSLSM-MV - 400 W	2		
<b>IP-65 Size for G. I. Mounting Pipe - 1 1/2" ID</b>						
	<b>S.V. Street Light Sheet Metal 1 PC Body</b>			A) DSLSM-SV - 70 W (Without Ignitor)	2	
				B) DSLSM-SV - 150 W	2	
			C) DSLSM-SV - 250 W	2		
			D) DSLSM-SV - 400 W	2		
<b>IP-65 Casting Body Size for G. I. Mounting Pipe - 1 1/2" ID</b>						
	<b>M.V. Street Light Sheet Dia Cast 1 PC Body</b>			A) DSLDC-MV - 80 W	2	
				B) DSLDC-MV - 125 W	2	
			C) DSLDC-MV - 250 W	2		
			D) DSLDC-MV - 400 W	2		
<b>IP-65 Casting Body Size for G. I. Mounting Pipe - 1 3/4" ID</b>						
	<b>S.V. Street Light Sheet Dia Cast 1 PC Body</b>			A) DSLDC-SV - 70 W (Without Ignitor)	2	
				B) DSLDC-SV - 150 W	2	
			C) DSLDC-SV - 250 W	2		
			D) DSLDC-SV - 400 W	2		
<b>IP-65 Casting Body Size for G. I. Mounting Pipe - 1 1/2" ID</b>						
	<b>Pot Optic Street Light for HPSV with T Glass</b>			A) DPOSL-MV - 80 W	2	
				B) DPOSL-MV - 125 W	2	
			C) DPOSL-MV - 250 W	2		
			D) DPOSL-MV - 400 W	2		
<b>IP-65 Single Ended Lamp Size for G. I. Mounting Pipe - 1 1/2" &amp; 2" ID</b>						

# INDUSTRIAL INDOOR OUTDOOR RANGE

Product	Dimension & Description L x W x H	Cat. Ref.	Pkg.	Price
<b>165</b> 	<b>Pot Optic Street Light for HPSV with T Glass</b>			
	<b>IP-65</b> <b>Single Ended Lamp</b> <b>Size for GI Mounting</b> <b>Pipe - 1 1/2" &amp; 2" ID</b>	A) DPOSL-SV- 70 W (Without Ignitor) 2 B) DPOSL-SV- 150 W 2 C) DPOSL-SV- 250 W 2 D) DPOSL-SV- 400 W 2		
<b>166</b> 	<b>Pot Optic Street Light for MHD with T Glass</b>			
	<b>IP-65</b> <b>Single Ended Lamp</b> <b>Size for GI Mounting</b> <b>Pipe 1 1/2" &amp; 2" ID</b>	A) DPOSL-MHD - 70 W 2 B) DPOSL-MHD - 150 W 2 C) DPOSL-MHD - 250 W 2 D) DPOSL-MHD - 400 W 2		
<b>167</b> 	<b>Street Light</b>			
	<b>Mounting Pipe Size</b> <b>1 x 40 - 1" ID</b> <b>2 x 40 - 1 1/2" ID</b>	A) DSL-TOP/SIDE -1 x 40 W 6 B) DSL- /SIDE -2 x 40 W 6		
<b>168</b> 	<b>Sigma - Street Light</b>			
	<b>Industrial Corrosion Proof</b> <b>IP 65</b> <b>With V.P.I.T. Ballast</b>	A) DSFTL - 1 x 36 W 5 B) DSFTL - 2 x 36 W 5		
<b>169</b> 	<b>T-5 Street Light Fitting</b>			
	<b>With Electronic Ballast.</b>	A) DT-5-ST - 4 x 14 W 2 B) DT-5-ST - 4 x 24 W 2		
<b>170</b> 	<b>Deluxe PLL Street Light</b>			
	<b>With Mini-Copper Ballast</b>	A) DDST - 4 x 36 W PLL 2		

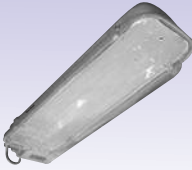
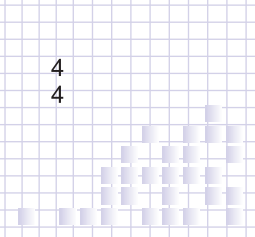
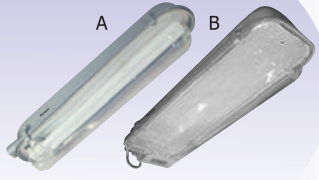
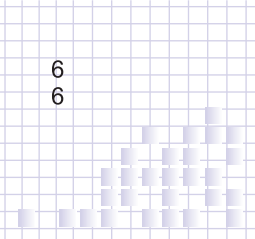
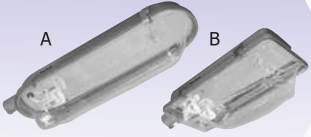
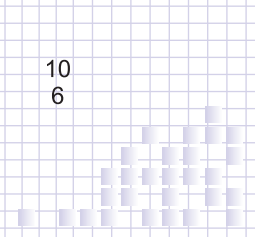

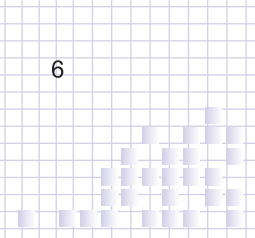

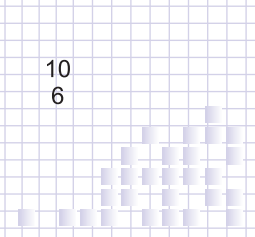
# INDUSTRIAL INDOOR OUTDOOR RANGE



Product	Dimension & Description					Cat. Ref.	Pkg.	Price
	L	x	W	x	H			
<b>171</b> 	<b>T5 Street Light</b>					A) DT-5-ST- 2 x 14 W	4	
	<b>With Electronic Ballast</b>					B) DT-5-ST- 2 x 24 W	4	
<b>172</b> 	<b>Deluxe PLL Street Light</b>					A) DDSL - 1 X 36 W PLL	6	
	<b>Mounting Pipe Size</b> 1 x 36 - 3/4" ID 2 x 36 - 1 1/2" ID <b>With Mini Copper Ballast</b>					B) DDSL - 2 X 36 W PLL	6	
<b>173</b> 	<b>PL Street Light</b>					A) D-SL - 1 X 11 W PL	10	
	<b>Mounting Pipe Size</b> 1 x 11 - 3/4" ID 2 x 11 - 1 1/2" ID <b>With PL Copper Ballast</b>					B) D-SL - 2 X 11 W PL	6	
<b>174</b> 	<b>CFL Street Light</b>					A) DCFLST - 85 W	6	
<b>175</b> 	<b>CFL Street Light</b>					A) DCFLST - 1 x 5 - 26 W CFL	10	
	<b>Mounting Pipe Size</b> 1 x 11 - 3/4" ID 2 x 11 - 1 1/2" ID					B) DCFLST - 2 x 5 - 26 W CFL	6	

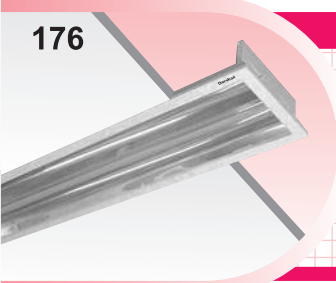

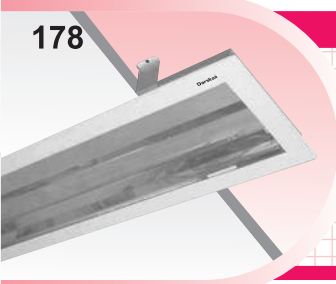
# CLEAN ROOM RANGE

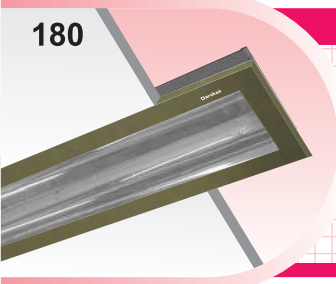
Product	Dimension & Description			Cat. Ref.	Pkg.	Price
	L	W	H			
 <p><b>176</b></p>	<b>Mirror Optic D.L. Recess with Acrylic Cover</b>					
	1225	165	100	A) D-MODLA - 1 x 40 W	3	
	630	230	100	B) D-MODLA - 2 x 20 W	3	
	1235	230	100	C) D-MODLA - 2 x 40 W	3	
	<b>With V.P.I.T. Ballast</b>					
 <p><b>177</b></p>	<b>Mirror Optic Recess with Acrylic Cover</b>					
	620	165	100	A) D-MORA - 1 x 20 W	3	
	1225	165	100	B) D-MORA - 1 x 40 W	3	
	630	230	100	C) D-MORA - 2 x 20 W	3	
	1235	230	100	D) D-MORA - 2 x 40 W	3	
	<b>With V.P.I.T. Ballast</b>					
 <p><b>178</b></p>	<b>Top Opening Fitting</b>					
	Tailor made as per customers requirement.			A) D-TOF - 2 x 40 W	2	
				B) D-TOF - 2 x 36 W PLL	2	
				C) D-TOF - 3 x 36 W PLL	2	
	<b>With V.P.I.T. Ballast</b>					
 <p><b>179</b></p>	<b>Bottom Opening Fitting</b>					
	Tailor made as per customers requirement.			A) D-BOF - 2 x 40 W	3	
				B) D-BOF - 2 x 36 W PLL	3	
				C) D-BOF - 3 x 36 W PLL	3	
	<b>With V.P.I.T. Ballast</b>					
 <p><b>180</b></p>	<b>Bottom Opening SS Fitting</b>					
	Tailor made as per customers requirement.			A) D-BOF SS - 2 x 40 W	3	
				B) D-BOF SS - 2 x 36 W PLL	3	
				C) D-BOF SS - 3 x 36 W PLL	3	
	<b>With V.P.I.T. Ballast</b>					

**NOTE**

- BODY : CRCA Powder-Coated
- REFLECTOR : Imported pre-anodized Aluminum reflector
- GASKET : Special XLPE i.e. Cross Linked Polyethylene Gasket is used.
- GEARTRAY : Removable gear tray is used for easy maintenance.
- DIFFUSER : Non yellowing, virgin acrylic sheet with high light transmittance.
- FRAME : Available is Stainless Steel / CRCA Powder Coating.

Prices for special application luminaires available as per specs / on request.





# GARDEN LIGHT



Product

Dimension & Description  
L x W x H

Cat. Ref.

Pkg.

Price

181



## Wings Light Fitting

A) D-MHD WINGS - 70 W	1
B) D-MHD WINGS - 150 W	1

With built-in Control Gear Box  
Size for Gi pipe 2 1/4" ID

182



## Post Top Lanterns

A) D-M/C/D Empty - 18"	3
B) D-M/C/D MV-80/125 W - 18"	3
C) D-M/C/D SV 70 W - 18" (without Ignitor)	3

1. Mushroom  
2. Conical

A, B & C) Size for Gi pipe 2 1/2" - 3" ID

183

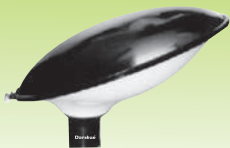

## Flying Soccer

A) D-FIS- Empty - 18"	4
B) D-FIS MV-80/125 W	4
C) D-FIS SV 70 W (without Ignitor)	4

Size for Gi pipe 18" - 2 1/2" - 3 ID

184



## Post Top Lanterns

A) D-PTL Empty - 12"	4
B) D-PTL Empty - 18"	4
C) D-PTL MV - 80/125 W	4
D) D-PTL MV 70 W (Without Ignitor)	4

Size for Gi pipe  
A) 12" - 1 1/2" ID  
B, C & D) 18" - 2 1/2" - 3 ID

185



## Garden Light Gola

A) DGL-G Empty - 8"	6
B) DGL-G Empty - 10"	6
C) DGL-G Empty - 12"	6
C) DGL-G Gola - 12" 10/13/18 W PL	6

GI Pipe Size for 1 1/2" - 2" ID







186



## Garden Light Diamond



A) DGL-D Empty - 8"	6
B) DGL-D Empty - 10"	6
C) DGL-D Empty - 12"	6
C) DGL-D Diamond - 12" 10/13/18 W PL	6

GI Pipe Size for 1 1/2" - 2" ID



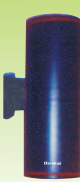

Product	Dimension & Description			Cat. Ref.	Pkg.	Price
	L	W	H			
<b>187</b> 	<b>Char Minar</b>			A) D CM - 13"	4	
				B) D CM - 20"	2	
			<b>GI pipe size 1 1/2" ID</b>			
<b>188</b> 	<b>PL Garden Light ( P.T.L.)</b>			A) D PTL - 1 x 11 W PL Clear / Black 12"	3	
				B) D PTL - 2 x 11 W PL Clear / Black 17"	3	
			<b>With V.P.I.T. Ballast</b>			
			<b>G.I. Pipe size</b>			
			12" - 1 1/2" - 2" ID			
			17" - 2 1/2" ID			
<b>189</b> 	<b>P.L. Garden Light ( P.T.L.) Mandir</b>			A) D PTL - M - 1 x 11 W PL	3	
				B) D PTL - M - 2 x 11 W PL	3	
			<b>With V.P.I.T. Ballast</b>			
			<b>G.I. Pipe size</b>			
			12" - 1 1/2" - 2" ID			
			17" - 2 1/2" ID			
<b>190</b> 	<b>Garden Light Mandir ( Lotus)</b>			A) DGL-LOTUS - 1 x 11 W PL	3	
				B) DGL-LOTUS - 2 x 11 W PL	3	
			<b>With V.P.I.T. Ballast</b>			
			<b>G.I. Pipe size</b>			
			12" - 1 1/2" - 2" ID			
			17" - 2 1/2" ID			
<b>191</b> 	<b>Garden Light GOLA ( One Piece )</b>			A) DIPC-GOLA - 10"	4	
				B) DIPC-GOLA - 12"	4	
			<b>G.I. Pipe size</b>			
			10" - 2 1/4" ID			
			12" - 2 1/4" ID			
<b>192</b> 	<b>Garden Light L SS Mandir</b>			A) DGL-SS-M - 9" CFL	4	
				B) DGL-SS-M - 12" CFL	4	
			C) DLH-SS-M - 9" CFL			4
			D) DLH-SS-M - 12" CFL			4
			<b>GI Pipe size</b>			
			9" - A & C			
			12" - B & D			
			A & B without Reflector			
			C & D with Reflector			

# GARDEN LIGHT

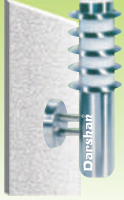

Product	Dimension & Description				Cat. Ref.	Pkg.	Price
	L	x	W	x			
<b>193</b> 	<b>Wings Light - Symmetric</b>				A) DWS - 35 W CDMT	3	
					B) DWS - 70 W CDMT	3	
				C) DWS - 150 W CDMT	3		
				<b>GI pipe size</b> <b>2 1/4" ID</b> <b>Without Control Gear</b>			
<b>194</b> 	<b>Wings Light - Asymmetric</b>				A) DWAS - 70 W MHL	3	
					B) DWAS - 150 W MHL	3	
				<b>GI pipe size</b> <b>2 1/4" ID</b> <b>With MHL Ballast</b>			
<b>195</b> 	<b>SLO-3 (B) Bollard (S.S)</b>				A) DB-SS-12" - GLS /CFL	10	
					B) DB-SS-18" - GLS /CFL	10	
				C) DB-SS-24" - GLS /CFL	10		
				D) DB-SS-30" - GLS /CFL	10		
				<b>Without Ballast</b>			
<b>196</b> 	<b>Fantasy Fiber Bollard</b>				A) DFFB- 1 x 18 W PL	2	
				<b>With V.P.I.T. Ballast</b>			
<b>197</b> 	<b>Fiber Bollard</b>				A) DFB-Bollard -1 x 18 W PL	2	
				<b>With V.P.I.T. Ballast</b>			
<b>198</b> 	<b>Up &amp; Down Par Lights</b>				A) D-PARL- 2 x 38 W	3	
				<b>With V.P.I.T. Ballast</b>			

# GARDEN LIGHT



Product	Dimension & Description			Cat. Ref.	Pkg.	Price
	L	x	W x H			
<b>199</b> 	<b>SLEEK - SS - Bollard</b>			A) DSB-SS-GLS/CFL	6	
	<b>Without Ballast</b>					
<b>200</b> 	<b>Wall SS. Bollard</b>			A) DWB-SS-GLS/CFL	6	
	<b>Without Ballast</b>					
<b>201</b> 	<b>Wall Bracket SS Bollard</b>			A) DWBB-SS-GLS/CFL	6	
	<b>Without Ballast</b>					
<b>202</b> 	<b>Spinz Light</b>			A) D-SPINZ - GLS	10	
	<b>Aluminum Casting Body Without Ballast</b>					
<b>203</b> 	<b>Outdoor Spike Light</b>			A) D-OSL - PAR 50	10	
	<b>Inground Fiber Water Proof Spike Light</b>					
<b>204</b> 	<b>Highlighter</b>			A) D-HLT - PAR 30	10	
	<b>Highlighter PAR fitting</b>					

# WALL BRACKET LUMINARIES

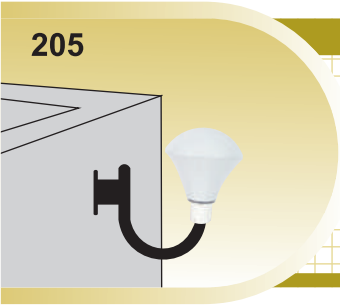
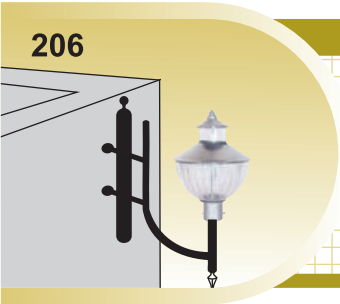
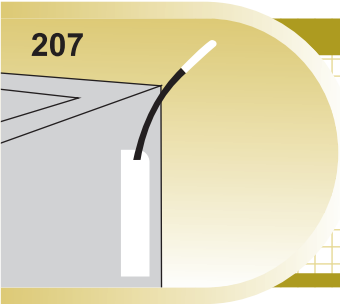
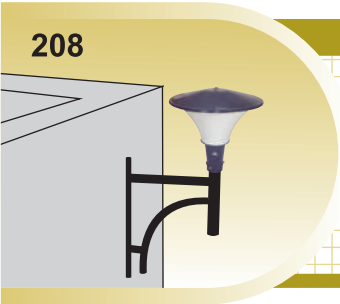
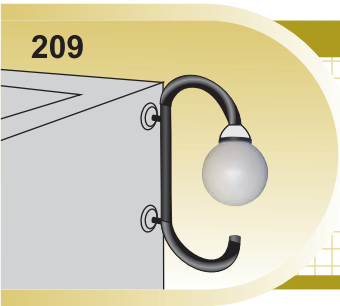
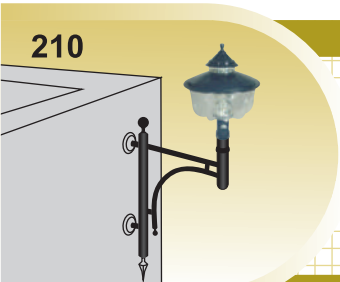



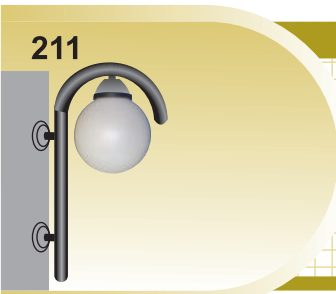
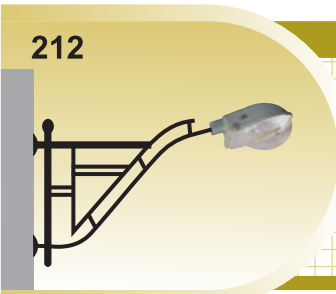
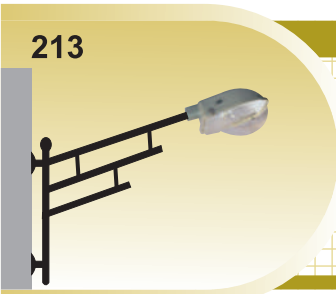
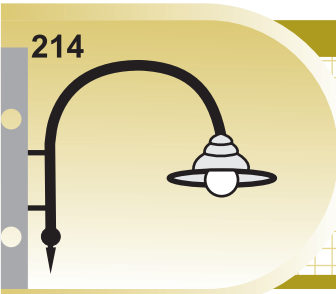



Product	Dimension & Description	Cat. Ref.	Pkg.	Price
	ID H Dia			
 <p><b>205</b></p>	<p><b>Voxon</b></p> <p>621/1 2 Ft. 2.0" Ø</p> <p>DWM VS</p> <p>Voxon made of MS Pipe bending wall mounting for se luminarie Lamp - 1 x 15 W CFLE</p>			
 <p><b>206</b></p>	<p><b>Archies</b></p> <p>622/1 2.5 Ft. 2.0" Ø</p> <p>DWM B AR</p> <p>Wall mounting bracket made of MS Pipe to suitable decorative luminaries Lamp - 1 x 18 W CFL</p>			
 <p><b>207</b></p>	<p><b>Roma ( Wall Tusker)</b></p> <p>623/1 3 Ft. 2.0" Ø</p> <p>DWM B RO</p> <p>Wall mounting bracket made of MS Pipe to suitable decorative luminaries 1/36 CFLL</p>			
 <p><b>208</b></p>	<p><b>Volga</b></p> <p>624/1 2.5 Ft. 2.0" Ø</p> <p>DWM B VO</p> <p>Wall mounting bracket made of MS Pipe to suitable decorative luminaries Lamp - 1 x 1 W CFLE</p>			
 <p><b>209</b></p>	<p><b>Colga</b></p> <p>625/1 3.0 Ft. 2.0" Ø</p> <p>DWM B CO</p> <p>Wall mounting bracket made of MS Pipe to suitable decorative luminaries Lamp - 1 x 15 W CFLE</p>			
 <p><b>210</b></p>	<p><b>Sholga</b></p> <p>626/1 2.5 Ft. 2.0" Ø</p> <p>DWM SO</p> <p>Single Arms MS Tube designed Wall mounting for suitable luminaries Lamp - 1 x 20 W CFLE</p>			

# WALL BRACKET LUMINARIES







Product	Dimension & Description ID H Dia	Cat. Ref.	Pkg.	Price
<b>211</b> 	<b>Exendra Compact</b> 627/1 4 Ft. 2.0" Ø	DWM XC - 15W		
	Single Arms MS Tube designed Wall mounting for suitable luminaries Lamp - 1 x 15 W CFLE			
<b>212</b> 	<b>Streetox</b> 628/1 2.5 Ft. 2.0" Ø	DWM SX		
	Single Arms MS Tube designed Wall mounting suitable for street luminaries Lamp - 70W/80W/SVMV			
<b>213</b> 	<b>Streeto</b> 629/1 2.5 Ft. 2.0" Ø	DWM ST		
	Single Arms MS Tube designed Wall mounting suitable for street luminaries Lamp - 70W, 80W / S.V.MV.			
<b>214</b> 	<b>Pelican Wall Mounting</b> 630/1 4.0 Ft. 2.0" Ø	DWM PE		
	Single Arms MS Tube designed Wall mounting suitable for street luminaries Lamp - 1 x 15 W CFLE			
<b>215</b> 	<b>Exendra-1</b> 631/1 8 Ft. 2.0" Ø 10 Ft. 2.0" Ø 12 Ft. 2.0" Ø	DWM X1		
	Exendra -1 Pole made of MS Pipe suitable for mounting glob luminaries designed for 1 x 15 CFLE Lamp			
<b>216</b> 	<b>Exendra - 2</b> 632/2 8 Ft. 2.0" Ø 10 Ft. 2.0" Ø 12 Ft. 2.0" Ø	DWM X2		
	Exendra -2 Pole made of MS Pipe suitable for mounting glob luminaries designed for 2 x 15 CFLE Lamp			

# POLE LIGHTING



Product	Dimension & Description			Cat. Ref.	Pkg.	Price
	ID	H	Dia			
	<b>Parabola - 2</b>			DWM PB2		
	633/2	8 Ft.	2.0" Ø			
		10 Ft.	2.0" Ø			
		12 Ft.	2.0" Ø			
Parabola - 2 Pole made of MS Pipe suitable for mounting glob luminaries designed for 2 x 15 CFLE Lamp						
	<b>Sine Wave - 2</b>			DWM SW2		
	634/2	8 Ft.	2.0" Ø			
		10 Ft.	2.0" Ø			
		12 Ft.	2.0" Ø			
Sine Wave - 2 Pole made of MS Pipe suitable for mounting glob luminaries designed for 2 x 15 CFLE Lamp						
	<b>Marina - 2</b>			DWM MA2		
	635/2	8 Ft.	2.0" Ø			
		10 Ft.	2.0" Ø			
		12 Ft.	2.0" Ø			
Marina - 2 Pole made of MS Pipe suitable for mounting diamond luminaries designed for 2 x 18 CFL Lamp with Lower & Copper Blast.						
	<b>Street Mega - 1</b>			DWM SMG		
	636/1	8 Ft.	2.0" Ø			
		10 Ft.	2.0" Ø			
		12 Ft.	2.0" Ø			
Street Mega - 1 Pole made of MS Pipe suitable for mounting half dome luminaries designed for 70 W HPSV Lamp						
	<b>Sphere - 2</b>			DWM SP2		
	637/2	8 Ft.	2.0" Ø			
		10 Ft.	2.0" Ø			
		12 Ft.	2.0" Ø			
Sphere - 2 Pole made of MS Pipe suitable for mounting Glob luminaries designed for 2 x 15 CFLE Lamp						
	<b>Empire - 2</b>			DWM EP2		
	638/2	8 Ft.	2.0" Ø			
		10 Ft.	2.0" Ø			
		12 Ft.	2.0" Ø			
Empire - 2 Pole made of MS Pipe suitable for mounting Light House luminaries designed for 2 x 18 CFL Lamp						





# POLE LIGHTING

Product	Dimension & Description			Cat. Ref.	Pkg.	Price
	ID	H	Dia			
	<b>Plazma - 3</b>			DWM PZ3		
	647/3	8 Ft.	2.0" Ø			
		10 Ft.	2.0" Ø			
		12 Ft.	2.0" Ø			
<p>Plazma - 3 Pole made of MS Pipe suitable for mounting Clear Globe luminaries designed for 3 x 15 CFLE Lamp</p>						
	<b>Phantom - 5</b>			DWM PT5		
	648/3	8 Ft.	2.0" Ø			
		10 Ft.	2.0" Ø			
		12 Ft.	2.0" Ø			
<p>Phantom - 5 Pole made of MS Pipe suitable for mounting Milky Globe luminaries designed for 5 x 15 CFLE Lamp</p>						
	<b>Cobra - 2</b>			DWM CB2		
	649/2	8 Ft.	2.0" Ø			
		10 Ft.	2.0" Ø			
		12 Ft.	2.0" Ø			
<p>Cobra - 2 Pole made of MS Pipe suitable for mounting Cobra Type luminaries designed for 2 x 11 CFL Lamp</p>						
	<b>Taskar - 1</b>			DWM TK1		
	650/1	8 Ft.	2.0"			
		10 Ft.	2.0"			
		12 Ft.	2.0"			
<p>Taskar - 1 Pole made of MS Pipe suitable for mounting Taskar Type luminaries designed for 1 x 36 CFL Lamp</p>						
	<b>Taskar - 2</b>			DWM TK2		
	651/2	8 Ft.	2.0" Ø			
		10 Ft.	2.0" Ø			
		12 Ft.	2.0" Ø			
<p>Taskar - 2 Pole made of MS Pipe suitable for mounting Taskar Type luminaries designed for 2 x 36 CFL Lamp</p>						
	<b>Opera - 1</b>			DWM OP1		
	652/1	8 Ft.	2.0" Ø			
		10 Ft.	2.0" Ø			
		12 Ft.	2.0" Ø			
<p>Opera - 1 Pole made of MS Pipe suitable for mounting diamond luminaries designed for 70 W SV / 80 W MV Lamp</p>						

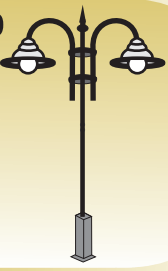

# POLE LIGHTING

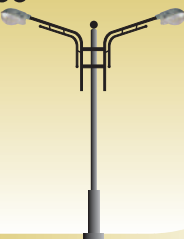
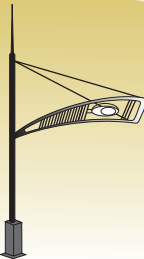

Product	Dimension & Description			Cat. Ref.	Pkg.	Price
	ID	H	Dia			
	<b>Opera-2</b>			DWM OP2		
	653/1	8 Ft.	2.0" Ø			
		10 Ft.	2.0" Ø			
		12 Ft.	2.0" Ø			
Opera - 2 Pole made of MS Pipe suitable for mounting luminaries designed for 2 x 15 CFLE Lamp						
	<b>Pelican - 1</b>			DWM PC1		
	654/1	8 Ft.	2.0" Ø			
		10 Ft.	2.0" Ø			
		12 Ft.	2.0" Ø			
Pelican - 1 Pole made of MS Pipe suitable for mounting luminaries designed for 70W / 80W / SV,MV Lamp						
	<b>Road King - 2</b>			DWM RK2		
	655/1	8 Ft.	2.5" Ø			
		10 Ft.	2.5" Ø			
		12 Ft.	2.5" Ø			
Road King - 2 Pole made of MS Pipe suitable for mounting luminaries designed for 2 x 15 CFLE Lamp						
	<b>Ring Lantern - 1</b>			DWM RL1		
	656/1	8 Ft.	2.5" Ø			
		10 Ft.	2.5" Ø			
		12 Ft.	2.5" Ø			
Ring Lantern - 1 Pole made of MS Pipe suitable for mounting luminaries designed for 70 W, 80 W / SV, MV Lamp						
	<b>Dual Palio - 2</b>			DWM DP2		
	657/2	8 Ft.	2.5" Ø			
		10 Ft.	2.5" Ø			
		12 Ft.	2.5" Ø			
Dual Palio - 2 Pole made of MS Pipe suitable for mounting luminaries designed for 2 x 150 W HPSV Lamp						
	<b>Palmera - 1</b>			DWM PM1		
	658/1	10 Ft.	2.5" Ø			
		12 Ft.	2.5" Ø			
Palmera - 1 Pole made of MS Pipe suitable for mounting luminaries designed for 1 x 150 MH Lamp						

Product	Dimension & Description			Cat. Ref.	Pkg.	Price
	ID	H	Dia			

**235**



**Street King - 1**

659/1	10 Ft.	2.5" Ø	
-------	--------	--------	--

DWM SK1

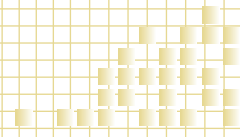

Street King - 1 Pole made of MS Pipe suitable for mounting luminaires designed for 1 x 250 MH Lamp

**236**

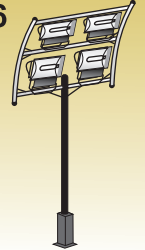

**Flood Stadium King - 3**

660/3	8 Ft.	2.5" Ø	
	10 Ft.	2.5" Ø	
	12 Ft.	2.5" Ø	

DWM FS3

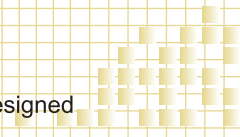

Flood Stadium King - 3 Pole made of MS Pipe suitable for mounting luminaires designed for 3 x 400 MH Lamp

**237**

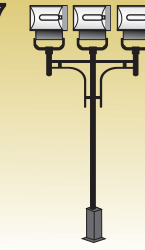

**Sport King - 4**

661/4	8 Ft.	2.5" Ø	
	10 Ft.	2.5" Ø	
	12 Ft.	2.5" Ø	

DWM SK4

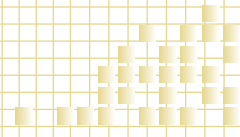











Sport King - 4 Pole made of MS Pipe suitable for mounting luminaires designed for 4 x 250 MH Lamp



# LED RANGE



Product	Description	Cat. Ref.	Pkg.	Price
<b>238</b>  Darshan	Small LED Fitting SS	1 W	30	
	With Power Supply			
<b>239</b>  Darshan	LED I - Ball	1 W	10	
	With Power Supply			
<b>240</b>  Darshan	Small Square LED Fitting SS	1 W	20	
	Round - With Power Supply			
<b>241</b>  Darshan	LED Fitting in Casting - Movable	2 W	10	
		3 W	10	
		6 W	10	
		7 W	10	
		12 W	10	
	Movable Type			
<b>242</b>  Darshan	LED Fitting in Casting - Fixed	2 W	10	
		3 W	10	
	Fix Type Fitting			
<b>243</b>  Darshan	Movable Small Led Fitting	1 W	10	
	Movable Type			

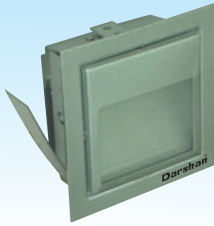





Product	Description	Cat. Ref.	Pkg.	Price
<b>244</b> 	<b>Movable Square Type LED</b>  <b>With Driver</b>	1 W	10	
<b>245</b> 	<b>Fix Type Square LED</b>  <b>With Driver</b>	3 W 6 W	10 10	
<b>246</b> 	<b>Fix Type Round LED</b>  <b>With Driver</b>	3 W 6 W 9 W	10 10 10	
<b>247</b> 	<b>LED Surface Fitting</b>  <b>With Driver</b>	1 W	10	
	<b>LED Put Light</b>  <b>With Driver</b>	1 Watt	15	
	<b>Put Light fitting with glass</b>  <b>With Driver</b>	1 Watt	15	

# LED RANGE

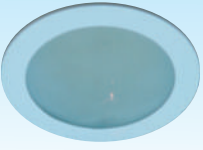

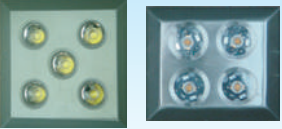
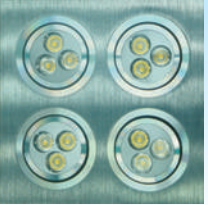

Product	Description	Cat. Ref.	Pkg.	Price
<b>250</b> 	Picture Light - Spring Type	DPL 6I S 1 Watt DPL12I S 1 Watt	10 10	
	With Driver			
	Picture Light Small SS	DPLS 1 Watt	10	
	With Driver			
	Picture Light SS	DPL 3 Watt	10	
	With Driver			
	Twin Picture Light SS	DPLT 2 x 3 Watt	10	
	With Driver			
<b>254</b> 	Trio Fitting	3 Watt 9 Watt	10 10	
	Trio with Driver			







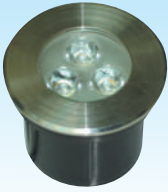

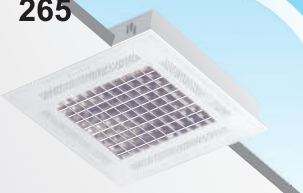
Product	Description	Cat. Ref.	Pkg.	Price
<b>255</b> 	<b>LED Down lighter LOC</b>	9 W	10	
		12 W	10	
		15 W	10	
		24 W	10	
		<b>With Driver</b>		
<b>256</b> 	<b>Deep LED Fitting</b>	6 W	10	
		7 W	10	
		<b>With Driver</b>		
<b>257</b> 	<b>LED Tapered Fitting</b>	4 W	10	
		5 W	10	
		<b>With Driver, Aluminium Housing</b>		
<b>258</b> 	<b>LED Movable Fitting</b>	12 W	10	
		<b>With Driver, Aluminium Housing</b>		
<b>259</b> 	<b>LED Movable Fitting</b>	9 W	10	
		<b>With Driver, Aluminium Housing</b>		
<b>260</b>  	<b>LED Movable Fitting</b>	3 W	10	
		6 W	10	
		<b>With Driver, Aluminium Housing</b>		

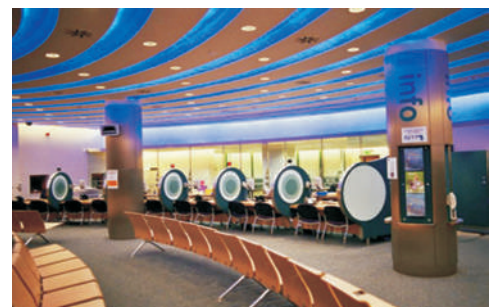
# LED RANGE

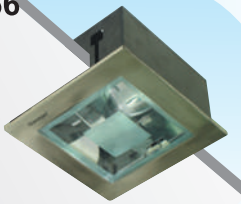
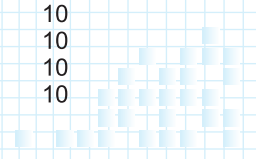

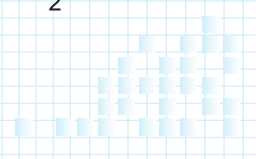
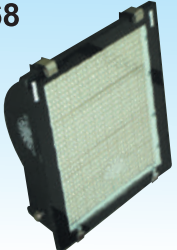
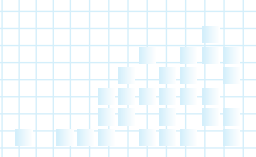
Product	Description	Cat. Ref.	Pkg.	Price
<b>261</b> 	Inground Light	1 Watt	10	
	With Driver IP 65 water proof			
<b>262</b> 	Inground Fitting	3 Watt	10	
		6 Watt	10	
		12 Watt	10	
		21 Watt	10	
	With Driver IP 65 water proof			
<b>263</b> 	LED - Down light SS	9 W	10	
		12 W	10	
		15 W	10	
	LED Down Light			
<b>264</b> 	LED - Simmi Light	26 W	10	
	LED Down Light			
<b>265</b> 	LED - Perforated Recessed	18 W	10	
		30 W	10	
		36 W	10	
	LED Down Light			

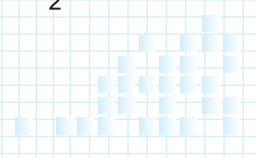

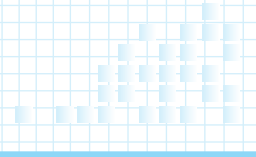
Product	Description	Cat. Ref.	Pkg.	Price
	LED - Down light Square SS	9 W	10	
		12 W	10	
		15 W	10	
		20 W	10	
		24 W	10	
		24 W	10	
With Driver				
	LED Street Light	50 W	2	
		65 W	2	
		Weather Proof Streetlight With Driver		
	LED Tempo Fitting	50 W	2	
		Weather Proof Tempo Fitting With Driver		
	Highbay With LED	50 W	2	
		30 W	2	
		With Driver		
	LED Streetlight	8 W	10	
		10 W	10	
		Weather Proof Streetlight With Driver		









# LED RANGE

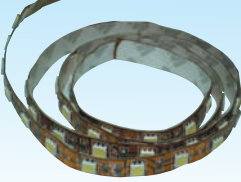
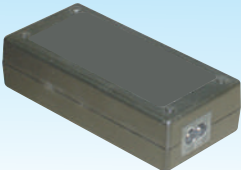

Product	Description	Cat. Ref.	Pkg.	Price
<p>271</p> 	<p>Streetlight With LED</p> <p>Weather Proof Streetlight With Driver</p>	<p>15 W 20 W</p>	<p>10 10</p>	
<p>272</p> 	<p>Spike light With LED</p> <p>With Driver</p>	<p>3 W</p>	<p>10</p>	
<p>273</p> 	<p>LED RGB Strip</p> <p>Without Driver, Rate in per Meter</p>	<p>8 W / Mtr</p>		
<p>274</p> 	<p>LED Strip</p> <p>White / Warm White / Red / Blue / Green / Orange Multicolour Without Driver, Rate in per Meter</p>	<p>5 W / Mtr</p>		
<p>275</p> 	<p>Rope Light</p> <p>White / Warm White / Red / Blue / Green / Orange Singlecolour Water Proof Without Driver, Rate in per Meter</p>	<p>5 W / Mtr</p>		

















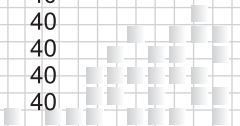

Product	Description	Cat. Ref.	Pkg.	Price
276	Power LED Strip	12 W / Mtr		
	Without Driver, Rates in per Meter			
277	Power Supply	12 W for 1 & 2 Mtr 30 W for 3, 4 & 5 Mtr	10	
				
278	RGB Multi-colour Remote Changer	1 W	2	
				
279	LED Driver	2 W 3 W 6 W 12 W 15 W 21 W 24 W	20	
	Electronic Circuit			
280	LED Bollard		2	
	With Driver & all accessories			

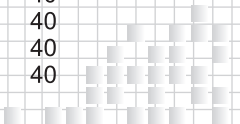

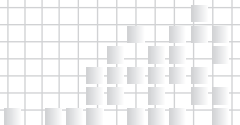
# ACCESSORIES

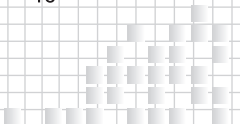

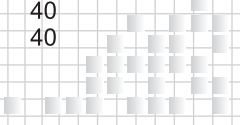

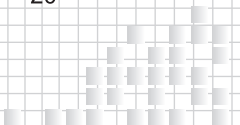

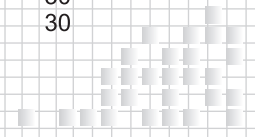

Product	Description	Cat. Ref.	Pkg.	Price
	Classic Ballast	A) DCB - 20 W	40	
		B) DCB - 40 W	40	
	Heavy Duty Aluminium Ballast	A) D HDAB - 10 W	40	
		B) D HDAB - 14/15 W	40	
		C) D HDAB - 30 W	40	
		D) D HDAB - 20/40 W	40	
	Heavy Duty Copper Ballast	A) D HDCB - Big - 20 W	40	
		B) D HDCB - Big - 30 W	40	
		C) D HDCB - Big - 40 W	40	
	Mini Copper Ballast	A) D-Mini B - 20 W	40	
		B) D-Mini B - 40 W	40	
	PL Copper Ballast	A) DPLB - 11 W	40	
		B) DPLB - 13 W	40	
		C) DPLB - 18 W	40	
	Heavy Duty / Copper Ballast	A) DHDAB - 54/58 W Aluminium	15	
		B) DHDCB - 54/58 W Copper	15	

Product	Dimension & Description			Cat. Ref.	Pkg.	Price
	L	x	W x H			
<b>287</b> 	<b>PL V.P.I.T. Copper Ballast</b>			A) D-VCB-PL - 9 W	40	
				B) D-VCB-PL - 10 W	40	
				C) D-VCB-PL - 11 W	40	
				D) D-VCB-PL - 13 W	40	
				E) D-VCB-PL - 18 W	40	
				F) D-VCB-PL - 26 W	40	
<b>288</b> 	<b>V.P.I.T. Copper Ballast</b>			A) D-VCB- 20 W	40	
				B) D-VCB- 30 W	40	
				C) D-VCB- 36 W	40	
				D) D-VCB- 40 W	40	
				E) D-VCB- Low Loss - 20/40 W	40	
<b>289</b> 	<b>12/50 W Transformer</b>			A) DET - 12 V / 50 W	30	
<b>290</b> 	<b>Electronic Ballast</b>			A) DEB - 1 x 20 W	40	
				B) DEB - 1 x 40 W	40	
<b>291</b> 	<b>PL Electronic Ballast</b>			A) DEB - 9 W PL	40	
				B) DEB - 11 W PL	40	
				C) DEB - 13 W PL	40	
				D) DEB - 18 W PL	40	
<b>292</b> 	<b>PL Electronic Ballast</b>			A) DEB - 2 x 18 W PL	20	
				B) DEB - 2 x 36 W PLL	20	

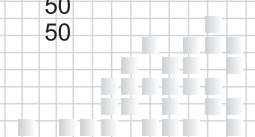
# ACCESSORIES

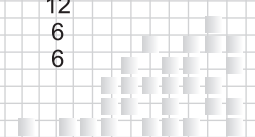

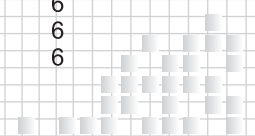
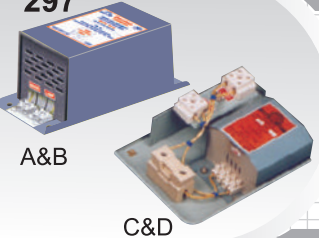
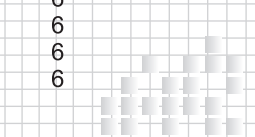
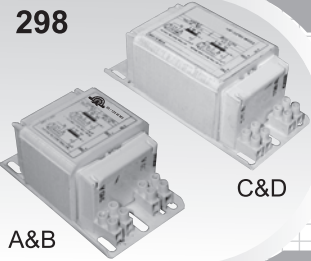
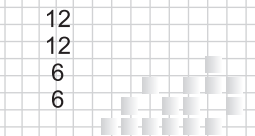
Product	Dimension & Description			Cat. Ref.	Pkg.	Price
	L	x	W x H			
<b>293</b> 	<b>T-5 Electronic Ballast</b>			A) DT-5-EB-14 W	30	
				B) DT-5-EB-24 W	30	
				C) DT-5-EB-28 W	30	
<b>294</b> 	<b>12/50 W Electronic Transformer</b>			A) D-ET - 12 V / 20 W	50	
				B) D-ET - 12 V / 35 W	50	
				C) D-ET - 12 V / 50 W	50	
<b>295</b> 	<b>Heavy Duty HPMV Copper Ballast</b>			A) D MVB - 80 W	12	
				B) D MVB - 125 W	12	
				C) D MVB - 250 W	6	
				D) D MVB - 400 W	6	
<b>296</b> 	<b>Heavy Duty HPSV Copper Ballast</b>			A) D SV/MHL B - 70 W	12	
				B) D SV/MHL B - 150 W	6	
				C) D SV/MHL B - 250 W	6	
				D) D SV/MHL B - 400 W	6	
<b>297</b>  A&B C&D	<b>Inbuild MHD Ballast ( IBU )</b>			A) DINB - MHD - 70 W	6	
				B) DINB - MHD - 150 W	6	
				C) D - WT MHD - 250 W	6	
				D) D - WT MHD - 400 W	6	
			<b>A&amp;B IBU Ballast</b> <b>C&amp;D Wiring Tray with Ballast</b>			
<b>298</b>  A&B C&D	<b>Open Type HPMV Ballast</b>			A) DMV-VCB - 80 W	12	
				B) DMV-VCB - 125 W	12	
				C) DMV-VCB - 250 W	6	
				D) DMV-VCB - 400 W	6	

Product	Description	Cat. Ref.	Pkg.	Price
<b>299</b> 	<b>Open Type HPMV Ballast</b>	A) DSV/MHL-VCB - 70 W	12	
		B) DSV/MHL-VCB - 150 W	6	
		C) DSV/MHL-VCB - 250 W	6	
		D) DSV/MHL-VCB - 400 W	6	

<b>300</b> 	<b>Fluorescent Starter Seat</b>	A) Patti Sheet ( Baliga)	
		B) Patti Sheet ( GLO )	
		C) Barrel Sheet	
		D) Push Sheet	
		E) Patti Push Starter Sheet	

<b>301</b> 	<b>Fluorescent &amp; PL Tube Holder</b>	A) Bracket Holder	
		B) Brass Holder	
		C) Push Holder	
		D) PL 2 Pin Holder 11/13/18 W	
		E) PLL 4 Pin Holder 18/36 W	

<b>302</b> 	<b>Fluorescent Starter</b>	A) Without Capacitor DS 20/40/65/80 W	300	
		B) With Capacitor DS 20/40/65/80 W	300	
		C) DS - 110 V 20 W	300	

<b>303</b> 	<b>Ignitor</b>	A) D2-SVF - Short Dis 70/400	
		B) D2-SV CG - Long Dis 70/400	
		C) D2-MHDF - Short Dis 70/400	
		D) D5-MHDCG - Long Dis 70/400	

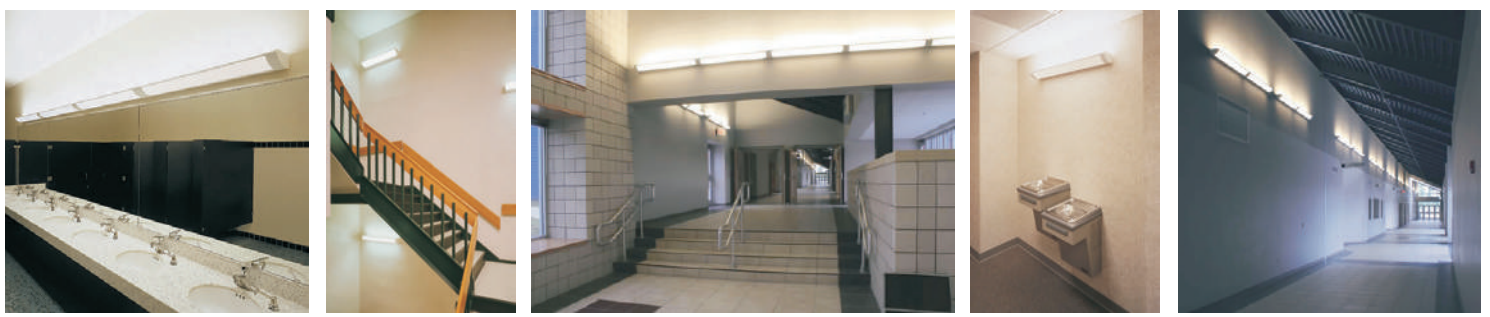

## ACCESSORIES & SPARES

### **(A) CONNECTOR -**

1) Patti Connector	Rs. 4.00
2) Fitting Connector	Rs. 6.00
3) Porcelain connector 15A	Rs. 12.00

### **(B) HOLDER -**

1) 80 / 125 W MVF 2 / 3 Pin Holder.	Rs. 11.00
2) 70 / 80 / 125 W SV/MVF Thread Holder.	Rs. 27.00
3) 150 / 250 / 400 W SV/MVF Thread Holder.	Rs. 65.00
4) 1x20 / 1x40 W Box Holder plate with Holder.	Rs. 12.00
5) 2x20 / 2x40 W Box Holder plate with Holder.	Rs. 23.00

### **(C) SIDE CAP (KAN) -**

1) Wall Line Corner Fitting Side Cap.	Rs. 33.00
2) 1x20 / 1x40 W Janta Side Cap.	Rs. 8.00
3) 2x20 / 2x40 W Janta Side Cap.	Rs. 15.00
4) PL - Janta Side Cap.	Rs. 7.00

### **(D) REFLECTOR (HIGHBAY) -**

1) 150 / 250 / 400 W M.V. / S.V. Highbay Reflector.	Rs.500.00
2) 150 / 250 / 400 W M.V. / S.v. Hook Reflector with Holder.	Rs.750.00

### **(E) REFLECTOR (INDUSTRIAL) -**

1) 1X20 / 2X20 W Industrial Reflector.	Rs.190.00
2) 1x40 W Industrial Reflector.	Rs.275.00
3) 2x40 W Industrial Reflector.	Rs.300.00
4) 1x40 / 2x40 W chalk Bord Reflector.	Rs.225.00

### **(F) POST TOP LANTERNS -**

1) 12" PTL Stand (Pole Cap)	Rs.230.00
2) 12" PTL Acrylic Doom.	Rs.160.00
3) 12" PTL Aluminium Canopy (TOP)	Rs.235.00
4) 18" PTL Stand (Pole Cap) Small	Rs.290.00
5) 18" PTL Stand (Pole Cap) Big	Rs.450.00
6) 18" PTL Acrylic Doom	Rs.185.00
7) 18" PTL Aluminium Canopy (TOP)	Rs.295.00
8) 18" PTL Mushroom / Conical / Drum (Pole Cap) Small.	Rs.310.00
9) 18" PTL Mushroom / Conical / Drum (Pole Cap) Big.	Rs.450.00
10) 18" PTL Mushroom / Conical / Drum Acrylic Doom.	Rs.215.00
11) 18" PTL Mushroom / Conical / Drum Alu. Canopy (TOP)	Rs.310.00

### **(G) ACRYLIC COVERS -**

1) 1x20 W Miroлта Acy. Cover Linning / clear.	Rs. 75.00
2) 1x40 W Miroлта Acy. Cover Linning / clear.	Rs.145.00
3) P.L. Miroлта 1x11 W. Acy. Cover clear / Linning / crystal.	Rs. 35.00
4) P.L. Miroлта 2x11 W. Acy. Cover clear / Linning	Rs. 60.00
5) 1x20 W Janta Acy. Cover Milky / clear.	Rs. 95.00
6) 2x20 W Janta Acy. Cover Milky / clear.	Rs.115.00
7) 1x40 W Janta Acy. Cover milky / clear.	Rs.220.00
8) 2x40 W Janta Acy. Cover milky / clear.	Rs.260.00
9) P.L. Janta Acy. Cover Diamond / clear.	Rs. 50.00
10) 2x20 W Recess Acy. Cover.	Rs.165.00
11)H 2x40 W Recess Acy. Cover.	Rs.290.00
12) 1x11 W PL Street light Acy. Cover.	Rs. 50.00
13) 2x11 W PL Street light Acy. Cover.	Rs. 65.00
14) 1x36 W PLL Street light Acy. Cover.	Rs. 65.00
15) 2x36 W PLL Street light Acy. Cover.	Rs.125.00
16) 1Xx40 W Street light Acy. Cover 2.5 mm.	Rs.105.00
17) 1x40 W Street light frame + Cover + Rubber.	Rs.200.00
18) 2x40 W Street light Acy. Cover.	Rs.130.00
19) 2x40 W Street light frame + Cover + Rubber.	Rs.250.00
20) 70/80/125/ W. M.V. / S.V. Street light Acy. Cover.	Rs.230.00
21) 150/250/400 W. M.V. / S.V. Street light Acy. Cover.	Rs.325.00
22) 1x11 W Simi light Acy. Cover.	Rs. 35.00
23) 1x36 W PLL Simi light Acrylic Cover.	Rs. 55.00
24) 1x18 W TLD Simi light Acrylic Cover.	Rs. 65.00
25) 1x36 W TLD Simi Acrylic Cover.	Rs.135.00

### **(H) GLASS -**

1) 500 W. Helogen Fitting Tuffen Glass.	Rs.125.00
2) 1000 W. Helogen Fitting Tuffen Glass.	Rs.200.00
3) Metal Hallide Fitting tuffen Glass.	Rs.125.00
4) 2x18 W. P.L. Bowl Fitting Glass.	Rs. 85.00
5) 70/80/125 W MV / SV Pot O Street Light T Glass	Rs.300.00
6) 150/250/400 W MV / SV Pot O Street Light T Glass	Rs.350.00

### **(I) CONDENSOR -**

1) 8 MFD Condensor	Rs. 50.00
2) 10 MFD Condensor	Rs. 60.00
3) 15 MFD Condensor	Rs. 85.00
4) 20 MFD Condensor	Rs.110.00
5) 33 MFD Condensor	Rs.170.00
6) 42 MFD Condensor	Rs.210.00

### **WITH FITTING**

<b>WITH COPPER CHOKE</b>	1 X 20 / 1 X 40	Rs. 50.00	<b>WITH CONDENSOR EXTRA</b>	1 X 40 / 2 X 40	Rs. 40.00	
	2 X 40	Rs. 100.00		<b>WITH ELECTRONIC CHOKE</b>	1 X20	Rs. 173.00
	4 X 20	Rs. 200.00			1 X 40	Rs. 173.00

### **General Notes :-**

- a) All price are subject to our general terms and condition of business
- b) Technical data & price are subject to change without prior notice.
- c) All price of luminaires are without Lamps / Tubes.
- d) Any statutory variation applicable of the time of delivery / sale will be to dealers / Purchasers account
- e) Spares not covered in the price list, can be offered on receipt of specific enquiry with description and quantities, it will charged extra.
- f) All wiring contact are ( Brass ) non corrosive.



**Darshan** luminaires is constantly developing & improving its products. For this reason, all products description, in this brochure are intended as a general guide. All specifications are subject to change without prior notice for further developments / improvements of the products

This “ **Darshan** ” catalogue cum pricelist has been totally designed to help you more easily to select the “ **Darshan** ” Luminaires range of products to meet your requirement & specifications.

### Warranty :-

All Our “ Darshan ” brand Chokes, Control Gear are warranted against any manufacturing defects for the period of as details follows.

- Heavy duty alluminium cloke 3 years warranty.
- Copper big choke 5 years warranty
- Open Ballast 2 years warranty.
- Electronic Ballast, Metal Halide Ballast, M. V., S. V. Ballast, Mini Copper Ballast 2 years warranty.

### Terms and Conditions :-

All prices are ex-works.

- The prices are exclusive of taxes, local levies, if any when will be extra as applicable.
- Payment Immediately.
- Delivery - : 8 - 15 days on confirmation of order.
- Packing charges extra.
- Less Discount \_\_\_\_\_%
- Subject to Mumbai Jurisdiction.
- All fragile parts of fitting such as plastic, acrylic louvers etc. are dispatched at buyers risk.



# Darshan

## ELECTRIAL INDUSTRIES

Jogeshwari ( w ), Mumbai - 400 102 (India)  
E-mail : darshan@darshanlighting.com  
Web : www.darshanlighting.com

Channel Partner :-